

# Home Boat Building

... made easy

by

The  
**BELL WOODWORKING CO. LTD.**  
PERCY ROAD — LEICESTER

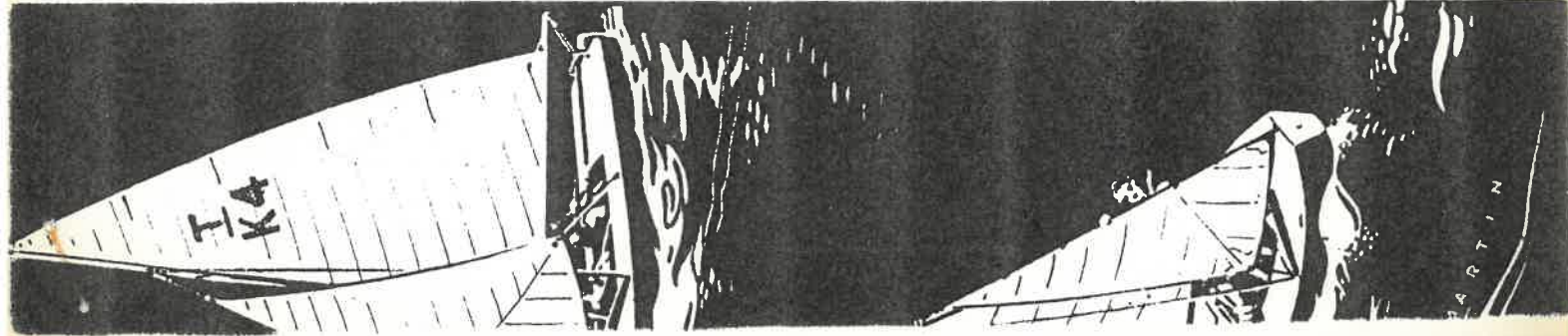

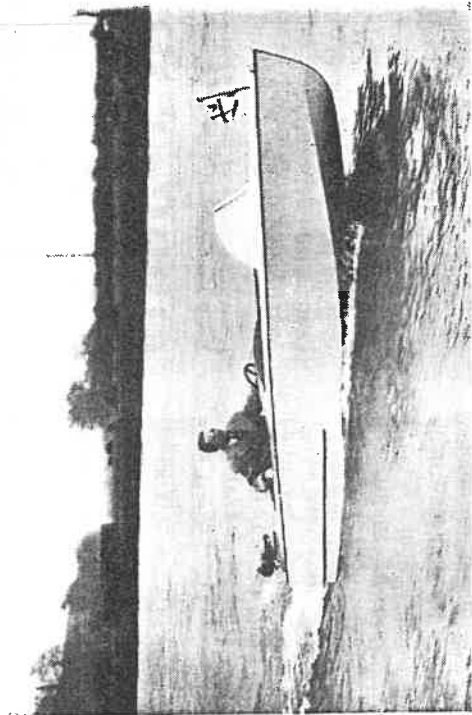
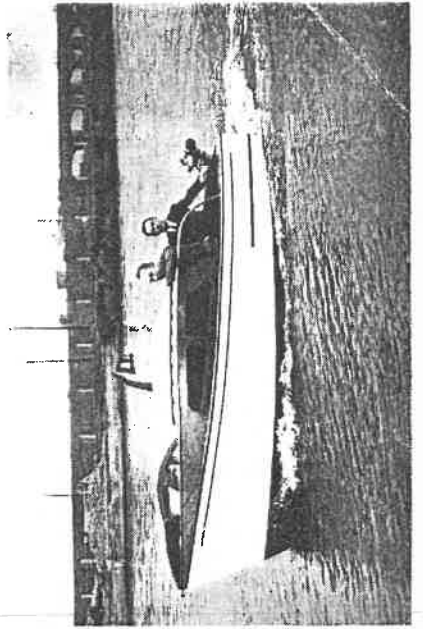
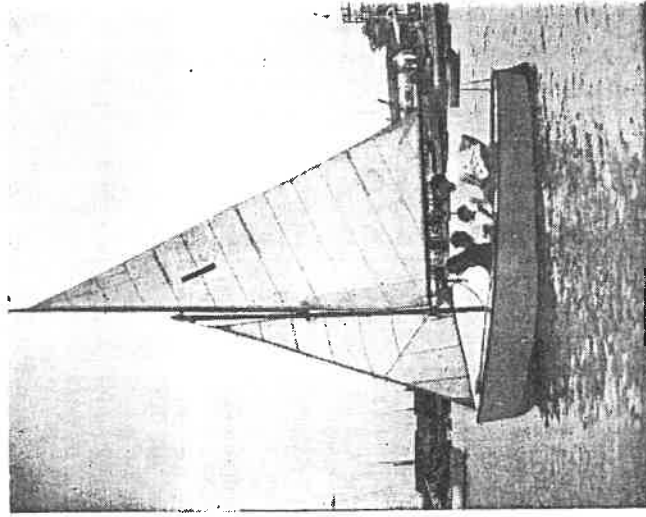
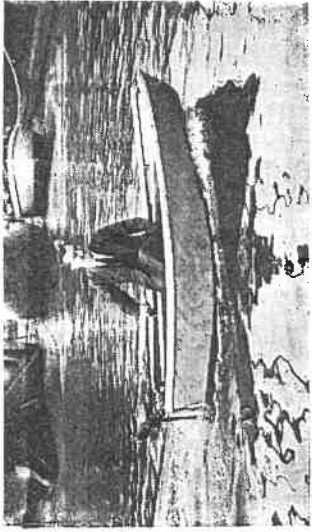

**Craft 8' to 18'  
From Prefabricated Parts**

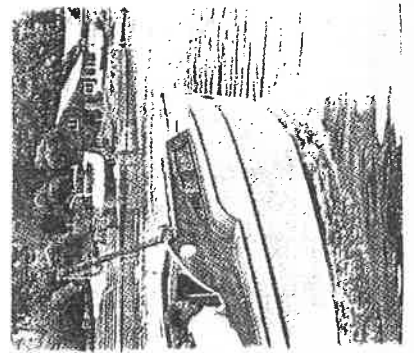
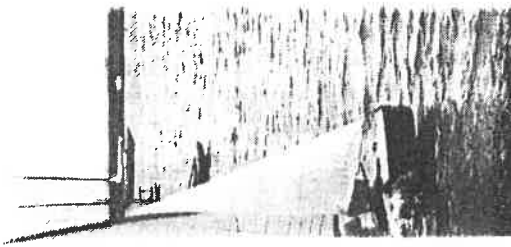
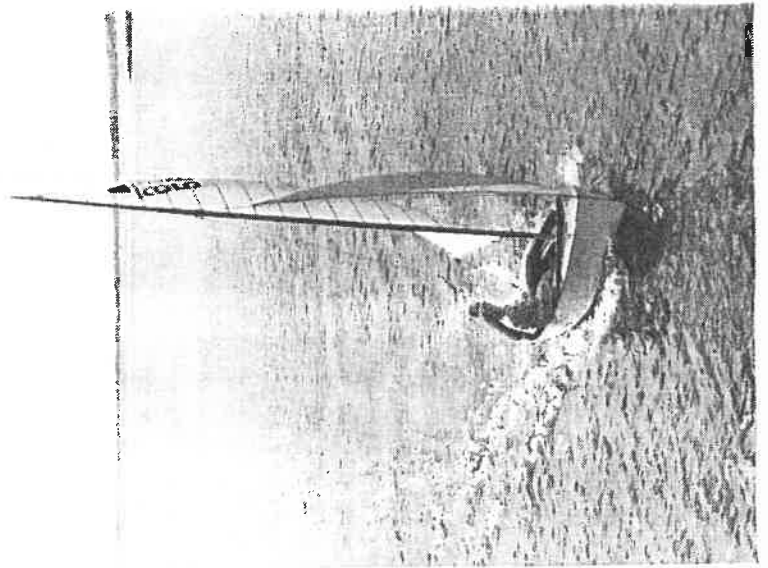

# Specialising in Prefabricated Boats

We are often asked why we make a speciality of boat building kits though the tremendous enthusiasm for the classes we have helped to create, and the constantly increasing demand for our products is almost sufficient answer in itself.

The costs of finished boats were so high after the war and have continued to increase in the intervening years that many would-be small craft enthusiasts, especially the younger ones, could not afford to buy a boat of any kind. The Yachting Journals realising this would prevent many from taking up the sport or even from continuing to enjoy the thrills of racing and sailing and knowing that approximately sixty per cent. of the costs of a small craft went into labour, turned their attention to fostering amateur building by offering detailed plans and instructions for various types of small craft.

The earliest postwar design of note was the "Yachting World" Cadet, designed by Jack Holt for Group Captain E. F. Haylock, who for many years had studied the idea of an ideal junior boat.

It had to be cheap and cost was saved by simplifying construction from sets of parts by amateurs. It is really a class racing dinghy in miniature and has already grown in numbers to the proportions of the long established National and International Classes. The boat handles like a thoroughbred and incorporates every known safety precaution.

As soon as timber controls were sufficiently relaxed we made jigs and supplied pre-shaped parts for this sailing dinghy. The kits resulted in amateurs building Cadets in half the time previously taken and at no cost extra to that of buying the necessary boards of timber planed square from the local timber merchant, as the relatively small cost of machining the various parts by modern high speed methods was offset by the advantage gained in bulk buying of timber direct from the importer and plywood from the actual manufacturer.

This is confirmed by the fact that we are told from time to time: "I built my boat from scratch

not being aware that prefabricated parts were available, and now find that my timber and plywood bills total more than your kit price."

Proof that prefabricated parts were time, money and trouble savers soon came in the form of orders from professional builders. One by one we adopted other designs suitable for prefabrication, and these, like the Cadet, were received with such enthusiasm that we decided to concentrate on the repetition production of precision machined boat parts, building finished boats mainly to ensure constant checking.

It was soon apparent that the only snag in amateur building was the necessity for making building stocks, a costly item in both time and money to the amateur and practically useless to him when the boat was completed. We overcame this difficulty by designing frames, stems and transoms that could be set up on the floor as shown in Figure 1.

Very little extra timber is required for this method and ample rigidity is achieved with less

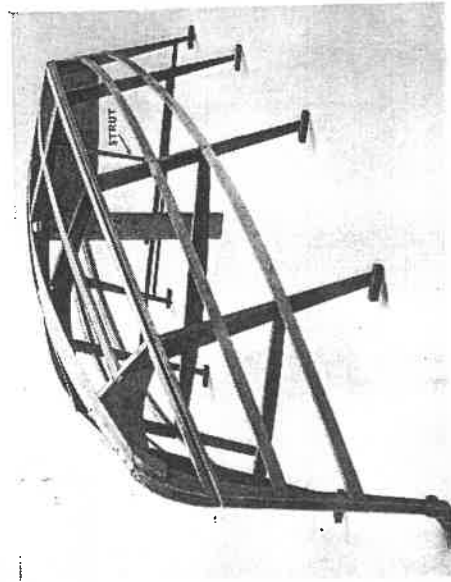

Fig. 1.—The "Yachting World" G.P. in frame showing how the extensions designed in the frame set up against floor blocks obviate any necessity for costly building stocks.

bracing than is usually required when using stocks. For example, this illustration of the G.P. 14' in frame (Figure 1.) shows only one bracing strut is necessary.

After planing a craft and turning it the right way up, the "horns" are cut off. These spare pieces represent a mere fraction of the costs of the stocks and even so, they are invariably used again in making some gadget for the finished craft.

Another great advantage in this method is provided by the floor plan issued with the plans, showing how the floor should be marked out for setting up the frames, and providing the floor is reasonably level, the lines and offsets are automatically correct. A correctly shaped boat is therefore bound to result.

We can only prefabricate boats calculated to have a wide appeal as the preparation of precision jigs is rather a costly item. It is for this reason that we cannot undertake the manufacture of a few kits to a special design. Once made, however, parts can be machined at an average rate of one-tenth the time taken by ordinary methods. The resultant value can be gauged from the number of kits exported. To export a kit involves adding anything between twelve and a-half and twenty per cent. of the total cost to pay for additional freight, packing, insurance and dock dues. Despite this our export orders are increasing all the time, regular consignments being sent to all parts of the world.

## WHAT PREFABRICATION REALLY MEANS

We take as much of the hard work as possible out of boat building leaving those jobs which in any case must be done by hand, to you. The frames of any of our kits will serve as an example. When we make these, the members are first planed square, then profiled according to position and recessed to receive gunwales, chines, hog and stringers if any. Deck beams are shaped to the required camber and a housing cut to receive the king plank. So much we do for you. If, however, a slight bevel was wanted on the edges, we do not machine this or you would have no latitude when it came to finally "fairing off" to receive skin or planking.

Bevels are a real problem. For example, if a frame required a lot of bevel as frame number one in Figure 1. we should machine most of it leaving



**GENERAL**

- A Boom.
- B Tiller.
- C Mainsheet.
- D Tiller Hood.
- E Rudder Stock.
- F Rudder Blade.
- G Top pintle & gudgeon.
- H Bottom pintle & gudgeon.
- I Kicking Strap.
- J Jib Sheet.
- K Jib " fairlead.
- L Chainplate.
- M Gooseneck.
- N Shrouds.
- O Centre board.
- P Bilge keel.
- Q Racing Flag.
- R Main halyard.
- S Head board.
- T Jib halyard.
- U Forestay.
- V Sail Batten.
- W Sail outhaul.

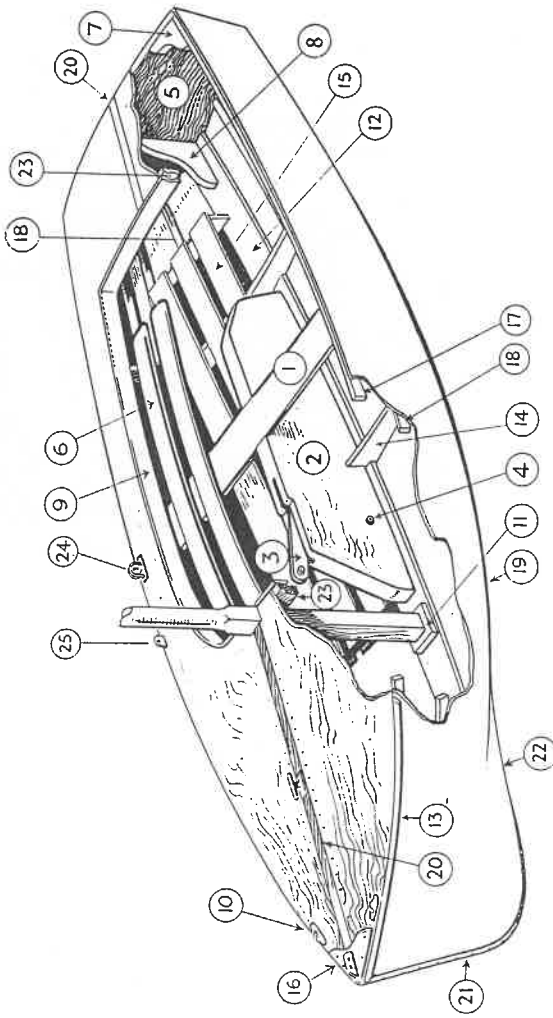
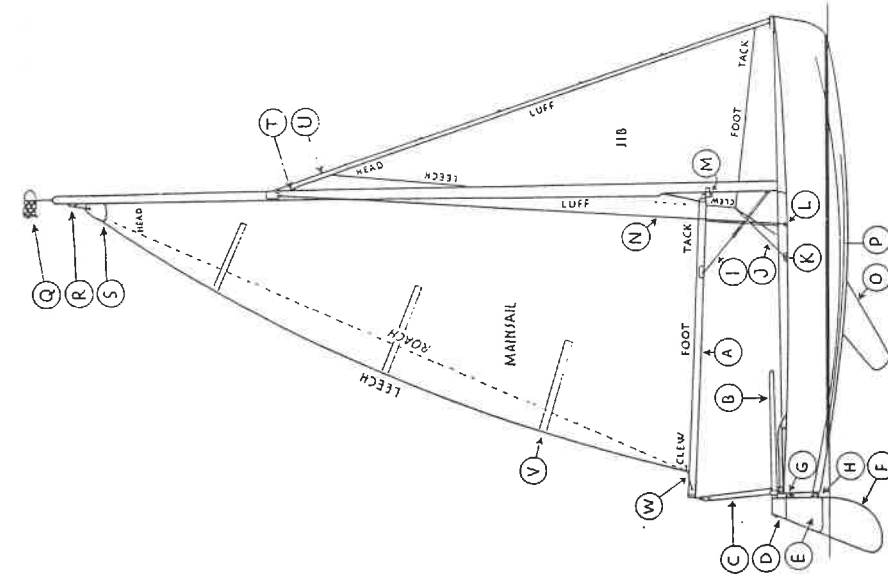

**HULL**

- 1 Thwart.
- 2 Centreboard case.
- 3 Centreboard.
- 4 Centreboard pivot.
- 5 Transom.
- 6 Side benches.
- 7 Quarter Knee.
- 8 Transom Knee.
- 9 Coaming.
- 10 Stem head fairlead.
- 11 Mast step.
- 12 Hog.
- 13 Rubbing bead.
- 14 Frames.
- 15 Floorboards.
- 16 Bow plate.
- 17 Gunwale.
- 18 Stringer.
- 19 Chine.
- 20 King plank.
- 21 Keel band.
- 22 Keel.
- 23 Deck beam.
- 24 Jib fairlead.
- 25 Chainplate.

you about ten per cent. margin for final fitting. This illustrates what we mean when we say "prefabricated as far as possible." Too great an accuracy leaving no margin for the slight variations that occur in any boat, might leave the builder in an awkward fix when finishing the craft.

Other parts such as rudders, tillers, centreboards, thwarts, floorboards and so forth are machined to such an extent that only fitting and sand papering are necessary.

Another example of "practical" prefabrication as opposed to "possible" prefabrication occurs in the long centreboard slot in the keel or hog. It would be easy for us to machine this as far as possible by a long unbroken slot, but this would

weaken the keel or hog too much for constructional purposes. We therefore make three short slots by leaving two webs, for practical reasons. These can easily be sawn out in a matter of seconds after the boat is completed.

Certain unit parts are completely assembled, these being specified in the various kits offered. Centreboard cases are usually completely assembled to prevent the wide boards from warping between manufacture and assembly. Frames too are assembled if we think these are better done in a master jig before despatch. Most dinghy frames require a very wide bench not usually found in the home workshop.

Briefly then, we machine every part to the

correct shape leaving where necessary, a bit here and there for the builder to fair off in course of assembly.

In every case only the very best timber is used and the specifications given are rigidly adhered to. If an acute shortage of any particular species is experienced we notify our customers of the substitute to be used before an order is accepted. Similarly, every piece of plywood supplied is specially made for us to the highest glueing grade (AX100) of the British Standards Specification 1088. This specification calls for a board which will stand a test of six hours immersion in boiling water, three hours in cold water and a further six hours in boiling water. Even so we insist that

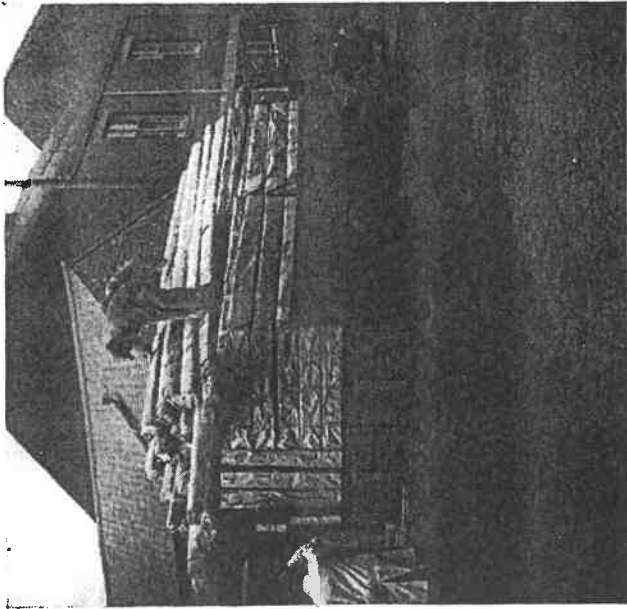

Fig. 2.—Part of a consignment of kits for the West Indies.

our plywood be made of mahogany throughout, that is, the inner veneers shall be the same as the outer veneers and glued with resorcinol glue. This results in a board which will stand a boiling test of 72 hours.

With very few exceptions all fittings, blocks and rigging are made by us and workmanship and finish is to the highest possible standards.

Masts and booms whether hollow or solid are sent out ready glued up and the utmost care should be taken in storing these until wanted. Although the natural urge is to start building the hull at once we strongly advise you to clean off and sand-paper the spars first giving them two coats of varnish before storing them away ready for a final coat of varnish when wanted.

Store them flat on a level floor or hang them up inside a garage. If hanging, be sure the mast is supported every four feet or so and if sunlight comes through a window, place sacking or similar material over the mast to prevent the sun striking any one part as this may "pull" it out of line, that is, cause the mast to warp.

Care is also needed in storing other parts until required. Wide boards should be stored flat with a little weight such as two or three building bricks on top to keep them straight.

Where necessary brief assembly instructions for the correct sequence of building are sent out with the kit but a few hints in general are not out of place here.

### ASSEMBLING A KIT

At some points it will be found that our parts vary a fraction from the issued plans. Such variations are a result of laying off the lines to full size from the plans and they occur in all boat-building, amateur and professional. Before starting to build study the plans, parts and any instructions until all is clear.

Tools in the average handyman's kit will be found all that is necessary for assembling prefabricated parts, for example, a two-inch adjustable plane, spokeshave, drill and bits, screwdrivers, paring chisel, mallet, hammer and one or two G cramps.

First of all let us be quite clear about a term often used in boat construction—"fairing off" or "fairing in." Boatbuilding, unlike most wood-working projects consists of more curved lines than straight ones, and because of this curved areas are the rule rather than the exception. This involves bevelling where structural members, for example frames, stringers, keel, hog and stem meet each other, or where the skin meets the framework. Bevels are, however, usually slight and best determined as the work proceeds.

The "Yachting World" General Purpose Fourteen Foot kit is a useful example to illustrate a few building hints. The floor, we assume, has been marked out from the plan provided, assembled frames set up to the correct side of the lines, and the transom has also been set up and rigidly braced. The hog and stem should have been glued and screwed together from the special instructions given.

The first step is fitting the hog. This has to lie over the frame edges which at the moment are square. Obviously the part of each frame to which the hog will be fastened will have to be bevelled slightly to ensure a snug fit.

The easiest way to determine the amount of bevel is to tack a thin springy lath of wood to the transom knee, lay it over the frames and mark off the amount of bevel shown by the lath to be required on each frame. Perhaps the next step, fitting the gunwales is a better illustration of "fairing in."

Using the temporary lath proceed as before in the recesses of the frames where the gunwale is to lie, but be sure sufficient "fairing in" is allowed for "fairing off" at a later stage when the skin is affixed. In other words, when the gunwale is finally fitted it should not be flush with the outer edge of the frame but should be slightly recessed to allow the edges of the frames to be smoothed away to make a close fit to the skin. This is more clearly demonstrated in Figure 3. The same procedure should be followed in fitting the chines.

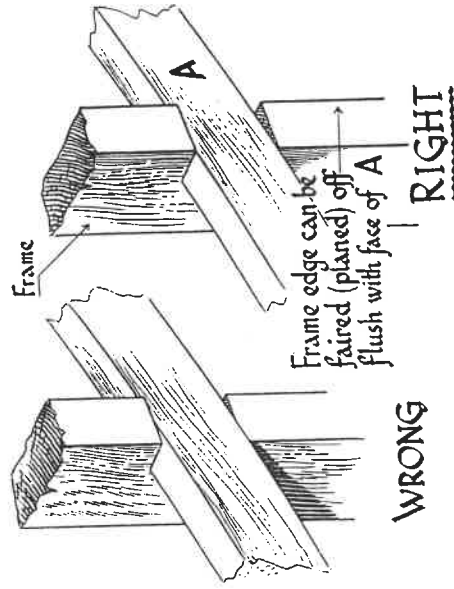

Fig. 3.—The right and wrong methods of fairing in a crossmember so that frame may be faired off later to take the skin.

Chines and sometimes gunwales require steaming to facilitate easy fixing. In small boat building, chines, gunwales and plywood can usually be made pliable enough by pouring a kettle full of boiling water over the required part. Extend the time of pouring as much as possible by keeping a stream of water, small but constant, moving over all faces of the timber continuously.

If steaming is really necessary a cheap, serviceable steamer can be made from galvanized rainwater pipe. Plug one end of the pipe which should be made long enough to contain the part of timber to be bent with a piece of wood about one inch in thickness, securing this in position with three or four screws through the pipe. Bore a hole in the plug to take the kettle spout and lightly pack the open end with a piece of cloth or sacking while steaming.

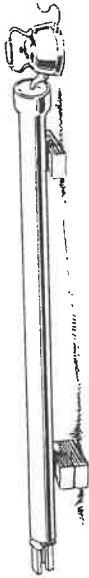

Fig. 4.—A cheap but highly efficient steamer can be made in a few minutes from a kettle and a piece of rainwater pipe.

As a rough guide to steaming time, allow one hour per inch of smaller dimension of timber plus an extra half hour, thus if the timber is  $\frac{3}{4}$ " x  $1\frac{1}{2}$ ", three-quarters of an hour plus half an hour is ample.

Fitting gunwales and chines up to the stem sometimes calls for a slender, compound angle that cannot be predetermined, but if the following procedure is adopted a good fit is easily obtained. It is always advisable to spring the gunwales or chines round together, to equalise the strain. Assuming you have brought round the chines from the transom end, cramp each end up to the stem face in turn and saw off the surplus as near as can be gauged. By using a cramp as the method illustrated (Figure 5) continue the sawcuts, using the stem side as a guide until a fit is obtained.

After hog, gunwales and chines in this order have been fitted, it is best to fair off all over to receive the plywood skin. Any stringers should be fitted after this has been done. Figure 6 shows a hull in frame being finally faired off to receive the planking. Where the sections are straight, use a small straight edge to ascertain bevels, but on curved sections use a fairing strip sprung to the approximate curve of the hull.

Before going on to the next step let us talk about plywood and glue. For many years professional builders of small boats have been looking for a material similar to plywood but able to withstand rigorous conditions of immersion in salt and fresh water at all temperatures. However, with the development of marine plywood immediately before

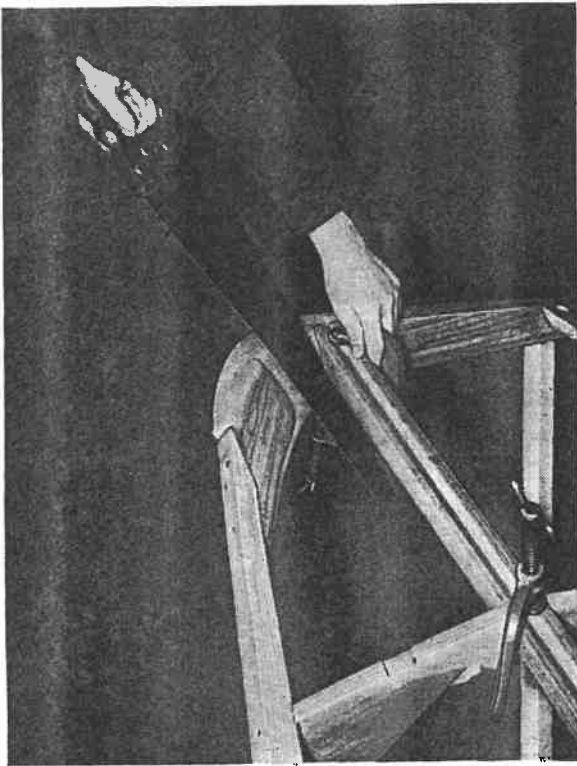

Fig. 5.—An easy method for obtaining the final fit for a compound bevel.



Fig. 6.—The process of fairing off straight and curved surfaces to receive the skin.

and during the war years it was the amateur builder who has benefited most. Tests have proved that plywood a little over half the thickness of timber planking will give the same strength. Joints are reduced to a minimum and these, when made with a gap filling Aerolite glue, result in an easily made permanent joint requiring no caulking or special treatment. Thus with the aid of marine plywood an amateur can build a boat in half the time previously taken with much better results in appearance and less likelihood of leaks.

Providing the plywood used is made with veneers of correct timber and stamped B.S.S. 1088, AX100 the most sceptical can use it with absolute confidence. It will stand temperatures near to boiling or freezing point without delamination. Unlike ordinary timber, plywood is uniform in strength, its expansion and contraction in any direction is calculable, whereas the planking of a timber hull is as strong as the weakest board. So reliable has marine plywood proved to be that its use is now the rule rather than the exception in planking small craft of every kind.

Owing to the high heat and pressure required in the manufacture of genuine marine plywood it is seldom obtainable in sheets more than eight feet in length. It is easily butt jointed, however, as shown in Figure 7. In this, panels are being joined on the actual hull. A backing strip about  $2\frac{1}{4}$ " wide of the same plywood is first let into the framing. The first panel is then glued and nailed into position by two staggered rows of copper nails, the projecting points of which are cut off to within about three-eighths

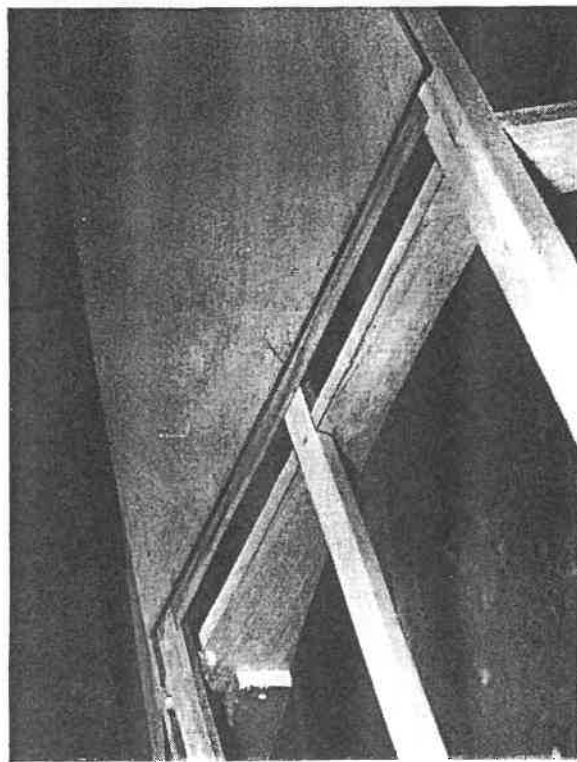

Fig. 7.—The plywood jointing strip let flush into the frame for butt jointing. An inch of the skin and clenched over. Surplus glue is immediately wiped off the backing strip to leave this clean to receive the second panel when required. When second panel is fixed be sure plenty of glue and hardener is used to seal end grain of plywood.

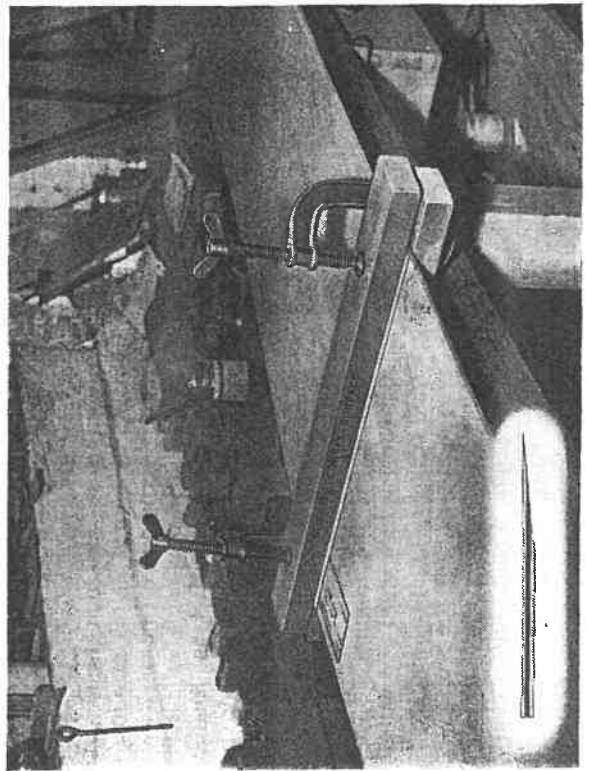

Fig. 8.—Method of using pressure bars in making a scarphed joint. The inset shows how the plywood should be bevelled.

Scarph jointing, although not lightly to be undertaken, can be done by amateurs. The panels to be jointed are first bevelled off to a feather edge for a width of at least eight times the thickness and for the whole length of the plywood. Bevelled faces are then glued and pressure applied. Pressure bars about three inches by four inches of hard wood, with a very slight convex face to ensure even pressure should be clamped over the joint as shown in Figure 8. Greaseproof paper is placed on both sides of the joint to isolate the glue. The joint should be held in position by two or three very small tacks nailed through both pieces of plywood to the bottom pressure bar to prevent side slip.

When fitting large panels the following procedure is advisable. Having fitted a panel to your satisfaction hold it in position with a few screws or nails. On the underside carefully mark all round the members to which it is to be fastened and remove the panel after marking around the screwholes for re-location. Then, guided by the outlines thus obtained, drill for screws or nails. Screws should vary from one and a-half to four inch centres and nails one and a-half to two and a-half inch centres according to the amount of tension to be overcome.

Holes should be drilled to a good tight fit to the shank of the screw and should not be countersunk if the screws will pull themselves flush, especially on surfaces to be varnished. Holes for larger screws will, of course, have to be countersunk. Panels are now ready for final fixing with glue and screws, there-

fore it is advisable to thoroughly understand the application of glue before proceeding further.

Modern synthetic resin glues have to be used before their strength and powers of resistance to all kinds of conditions can be appreciated. These glues can be divided into two groups (i) separate application types and (ii) premixed types.

We consider Aerolite 300 with the GB hardeners to be the best of the separate application group and ideal for boat building. It is not merely one of several thoroughly reliable, resin glues, it is in fact, superior to all other glues of its group. Aerolite 300 is the only gap filling glue that can be used by the simple separate application method. This advantage is considerable. The glue is applied

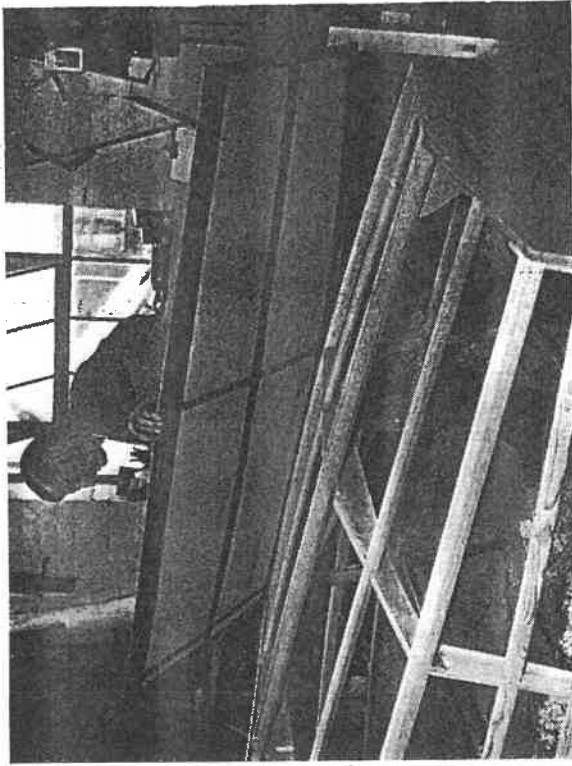

Fig. 9.—Immediate fixing of panel after spreading hardener.

to one surface and the hardener to the other.

Perhaps the most important quality of Aerolite 300 however, is the greatly superior strength and durability of joint it ensures. This characteristic is evident both in constructional joints made in the workshop and in the various reports issued by the Forest Products Research Laboratory. To obtain the best results it is as well to understand thoroughly its application.

A report issued by the R.A.E. of tests carried out in the Tropical Testing Establishment, Nigeria, shows that 'Aerolite' 300 is equal, often superior in durability to phenolic and resorcinol resins. To



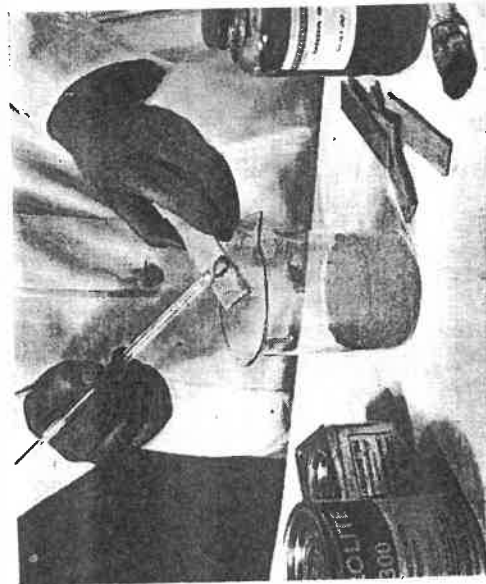

A thin layer of "Aerolite" 300 is spread on one face of the joint. Obtain the best results, however, it is as well to understand thoroughly its application.

As we have already stated it is necessary only to apply the glue to one surface to be joined and the hardener to the other. The glue can best be spread with a piece of wood and the hardener with a brush made without metal for preference.

When using \*Aerolite 300 with the GB



GB Hardener is brushed on to the other face and the two joint members are brought together. No pressure is required beyond the amount necessary to hold the surfaces firmly together during setting.

\* "Aerolite" 300 is manufactured by Acro Research Limited, Duxford, Cambridge, who would gladly send you further information regarding their products and advice on any technical problems.

hardeners it is essential that the hardener covered surface should be wet or at least damp when the joint is closed, therefore we recommend that the glue is always applied first and the hardener brushed on just before you are ready to make the assembly. When the two surfaces have been brought together do not displace them in relation to one another if you can possibly avoid doing so. However you have a certain amount of shuffling time in which to adjust your assembly before finally screwing down. Three hardeners are supplied with Aerolite 300:—

- Fast Setting ..... GBQ.X
- Medium Setting ..... GBP.X
- Slow Setting ..... GBM.X

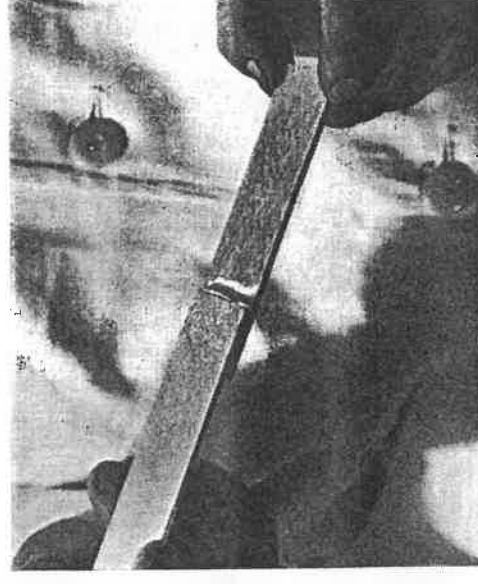

The joint conforms to B.S. 1204/B.70: in a test to destruction, failure normally occurs in the wood and not in the glue line.

It is useful to know the significance of these three hardeners although for all practical boat building purposes we have found that the slow setting hardener GBM.X is the most convenient. In general it is best for the glue to harden as quickly as possible and under normal workshop temperature conditions, say between 60°F and 70°F. Aerolite 300 with the slow hardener GBM.X will harden sufficiently for the joint to be worked on after four or five hours.

As a contrast, when using the fastest hardener GBQ.X the clamping time under the same conditions would be about two hours. However, the time allowed to adjust the assembly after the surfaces have been brought together is much less

when using the fast hardener GBQ.X than with the slow hardener GBM.X. In fact at a temperature of 70°F this permitted time, known as the closed assembly time or shuffling time is:—

- 5 minutes for the fast setting hardener GBQ.X
- 10 minutes for the medium setting hardener GBP.X
- 20 minutes for the slow setting hardener GBM.X

These are the times for a temperature of 70°F., at lower temperatures longer shuffling times are permissible and vice versa. Thus for the slow hardener GBM.X the permissible shuffling times over a range of temperatures are as follows:—

Temperature	50°F.	60°F.	70°F.	80°F.
Time in minutes	60-70	40	20	10

Except where the workshops are very cold we advise the use of the slow hardener since a greater tolerance in shuffling time is obtained.

From this it will be appreciated that in putting on large panels with Aerolite, they should be fitted dry as previously mentioned, the glue and the hardener then applied and the panel replaced and located in position by means of the pilot screws used on the previous fitting. After doing this, complete the screwing or nailing as quickly as possible. In general the hardeners are supplied in colourless form giving an absolutely clear glue line. However, for certain work it is an advantage to have these coloured so that it can be seen at a glance if the hardeners have been applied or not. As the different hardeners each have a distinguishing colour it is possible to recognise immediately which particular grade of hardener has been used. When ordering a coloured hardener it is necessary only to omit the suffix X. Therefore if the slow hardener GBM.X is required in coloured form it should be ordered as GBM. The distinguishing colours given to the hardeners are as follows: GBQ—brown, GBP—green, GBM—purple.

When using Aerolite 300 it is not essential to have close fitting joints as the glue itself will take up a considerable gap. In fact, too much pressure will often force the glue out and cause a weak joint through glue starvation. Care must be taken to ensure that the surfaces are clean and free from oil, grease and grit, and reasonable care is needed to get the best results with Aerolite.

Plywood surfaces can, with advantage, be slightly roughened by coarse sandpaper over the surface to be glued, especially some forms of mahogany plywood which leaves the press hard and smooth.



Aerolite is also supplied in powder form, Aerolite 306 and this powder is mixed with water to produce the liquid glue (Aerolite 300). Aerolite 306 has the advantage that it can be stored for at least two years without deterioration. The liquid form, Aerolite 300 is really more convenient in that it is ready for use and if kept under reasonable conditions will last for at least three to four months.

#### FITTING THE SKIN

When fixing the decks, glue and nail or screw around the outside edges only, otherwise in certain climatic conditions they will take on a corrugated effect. The only exception to nailing is where a rebated king plank is used.

Here it is advisable to use small screws finishing with the slots in line as king planks in small craft are neither heavy enough, nor sufficiently solid for nailing.

Providing the boat is especially designed for plywood and the plans are followed exactly, planking the boat with plywood is a very simple job.

The designer will have worked out the permissible curves and will have shown the chosen arrangements (there are many) to be followed. According to the method chosen, two points may present some difficulty to the amateur until explained. One is the fitting of the forward bottom panel and the other is the changeover from lap to butt joint on the chine of some designs.

Take the bottom panel of a design such as in Figure 10. The plywood has to be fitted up to a

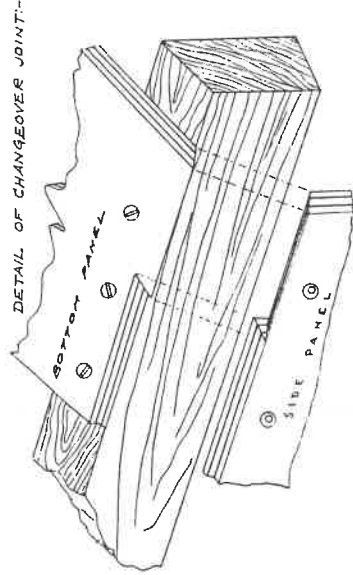

Figure 10.

rebate and under tension. In a case like this much time is saved if a sheet of good quality brown paper is pinned over the part to be covered. It should lay flat with no wrinkles or creases, then, by rubbing a thumb over the external corner of the rebate, the paper will be marked accurately and

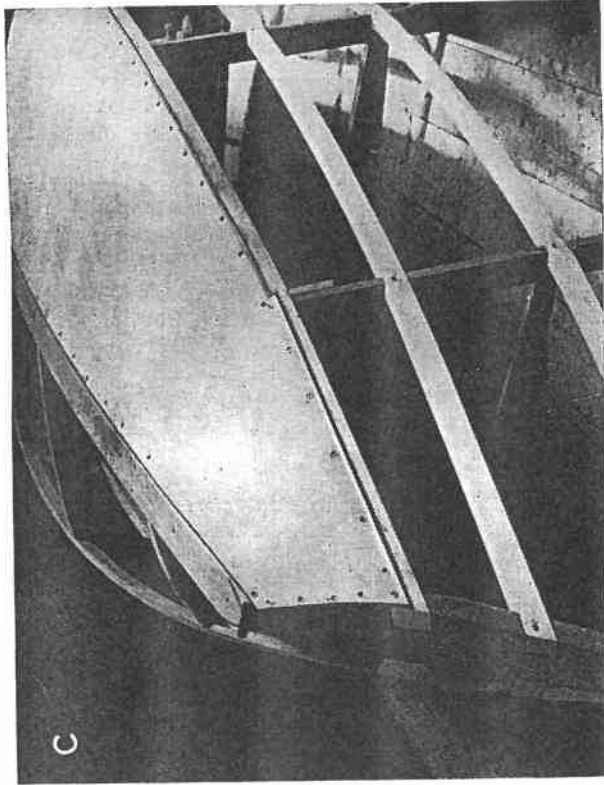

Fig. 10.—Fitting the forward bottom panel.

sufficiently to cut a pattern. Finally, carefully mark out the plywood to correspond, cut dead to the line and you will find you have very little difficulty in the fitting. If, as so often happens, the plywood is found too stiff to bend to the required position, do not hesitate to pour boiling water slowly over both faces and cramp it into the required position quickly. Leave the panel so fixed for an hour or two whilst getting along with another job. Never glue timber with resin glue until the faces to be joined are reasonably dry.

In some hard chine construction the skin has to change from an overlap to a butt joint at a point usually about two or three feet from the stem, the point of changeover being shown on good plans. Here again methods vary and should be shown on the plans. The only method likely to puzzle amateurs is the one also shown in Figure 11, which demonstrates the method very plainly. The bottom panel is fitted first and the topside panel fitted to suit.

Except for small pram dinghies it is generally agreed that hard chine boats look much better with painted hulls (not decks). Where it is intended to finish the hull in clear varnish use copper nails for fastenings instead of screws wherever possible. Actually, if glueing instructions are properly carried out there is no need to use screws on the topsides except at the transom, stem, gunwales and chines. Gunwale screw heads will later be covered by the rubbing strake, therefore if copper nails are substituted for screws in frames and stringers this will improve the appearance.

Decks that are varnished look so much nicer if nailed and glued on, and the nails finally filed flush just before varnishing—that is while the heads are still bright. Decks should always be glued as this prevents any tendency to "work."

The whole of the bottom should be screwed to close centres along the keel or garboard joint as it is called.

#### THE CENTREBOARD CASE

In sailing dinghies, ensuring a watertight fit for the centreboard case may be the cause of some anxiety, for this is a traditional source of weakness and leaks in centreboard craft. After trying many methods we have finally devised the following means of ensuring a one hundred per cent joint without any complicated fitting.

First plane the bottom of the case to fit the curve of the hog to within one-sixteenth of an inch. With the case in position, mark the hog around the case. Drill holes accordingly for the screws at not more than two and a-half inch centres, then fix the case temporarily with six screws and counter-bore for the remainder. Remove the case and clean off any burrs. Then place Prestik tape over the area of the joint and carefully fix the centreboard case in the same position by means of the six screws previously used and finally secure the remaining screws. A word of caution—when applying the tape make sure it fits precisely, edge to edge, and that nowhere does any edge of the tape overlap an adjacent strip. This is very important since an irregularity in the thickness of tape means that the case cannot be screwed evenly down on to it or a source of future leaks may be made.

Prestik tape has a cellophane covering on one face, if this proves difficult to remove place the tape in warm water.

Go over all the screws again and tighten up as much as possible. Prestik tape (which we supply) never sets hard, therefore squeeze out as much as possible by screwing tightly. The screws should be tightened up again two days after fixing and to be on the safe side, again two days later.

A word or two about screws and screwdrivers will not be amiss here. Ordinary screwdrivers are fairly cheap and one should be obtained for each size of screw, say one for six, eight and ten gauge. Carefully file the screwdriver end until it will fit the screw slot well enough to hold the screw in a horizontal position without falling off. When screwing into hard wood bore for the shank of the screw and counterbore for the thread of the screw using the bits shown here as a guide:

Screw-Gauge	4	5	5	7	8	10	12	14
Bore	1/8	1/8	5/32	5/32	3/16	7/32	1/4	1/4
C/bore	Bradawl		1/16	1/16	3/32	1/8	1/8	5/32

To prevent drilling too deep for the shank measure off a bit of wood dowelling, drill through and leave it on the drill to act as a stop.

Always have a grease pot handy, vaseline or grease of similar colour and density is ideal. For larger screws, dip the thread part into the grease before using. Screws enter the wood more easily and there is less likelihood of breaking a brass screw on the final turn.

In the centreboard case fitting previously mentioned, where the screws have to be tightened a second time, it is essential to use grease.

#### Suitable sizes or gauges for brass wood screws

Length in inches	1/2	5/8	3/4	1	1 1/4	1 1/2	2	2 1/2	3
Size No.	4	4 1/2	5	6	6 1/2	7	8	8 1/2	10

### DETAILS OF CONSTRUCTION

So far we have dealt with the main construction, now let us consider a few isolated points.

King Planks are narrow pieces of wood running centrally along the decks, let into and connecting the deck beams. If a rebated king plank is used it not only strengthens the deck (its prime purpose) but improves the appearance immensely (see the Y.W. Car-Top Dinghy foredeck) and at the same time allows the deck to be fitted in halves which is easier than one whole and cheaper, there being less waste.

Extend raised part of king plank beyond stem. Trim off later.

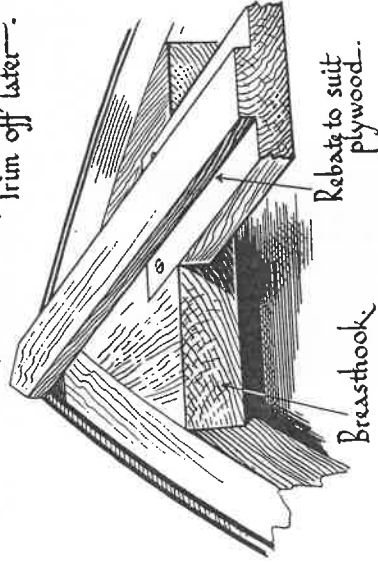

Figure 12.

Housing the ends of a rebated king plank may prove a bit puzzling at first, but a few minutes study of Figure 12 which shows housing end into the breast hook will soon make the method clear.

Housing the opposite end into the deck beam is similar except that the body of the plank is let into one half of the deck beam only unless a coaming is being planted on the beam later. In this case the whole of the king plank comes right through the beam and is trimmed off flush with the face, the coaming cloaking the joint later as is shown in Figure 13.

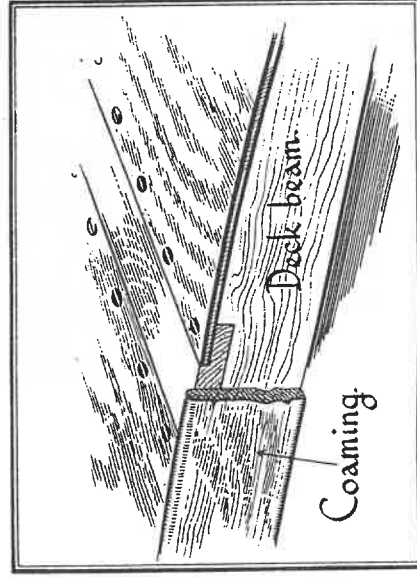

Figure 13.

Cockpit coamings add greatly to the appearance of any dinghy, the timber being very thin costs little extra and the small additional weight can often be compensated for by substituting softwood

carlins and deck beams for hardwood ones as these will not be seen when coamings are fitted.

If you have the time and four or five G cramps at your disposal, coamings can be glued on. One piece glued on each night and morning uses the cramps to advantage. The benefit of glueing coamings is that no screws show, a very desirable thing at this point as clothes constantly rub against side coamings and if screws are badly seated or slots a bit rough, damage to jackets and trousers soon results.

Glue the coaming into position and hold it there for the time required by G cramps, preventing these from marking the face of the timber by placing a bit of scrap wood under the cramp heads.

Deck beams are normally dovetailed into gunwales but in small dinghies with plywood decking this method can be considerably simplified as shown in Figure 14.

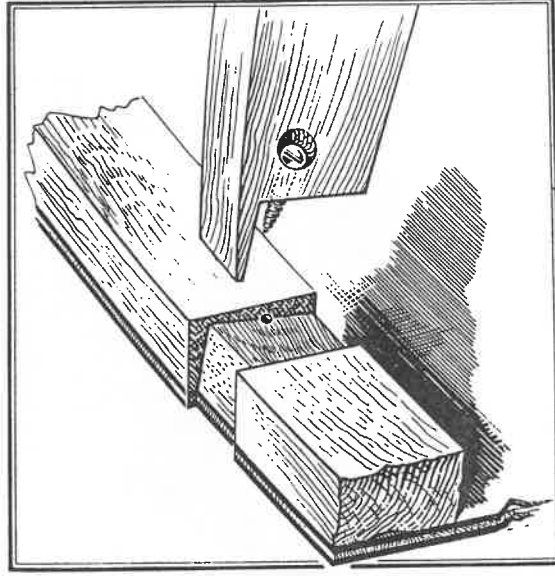
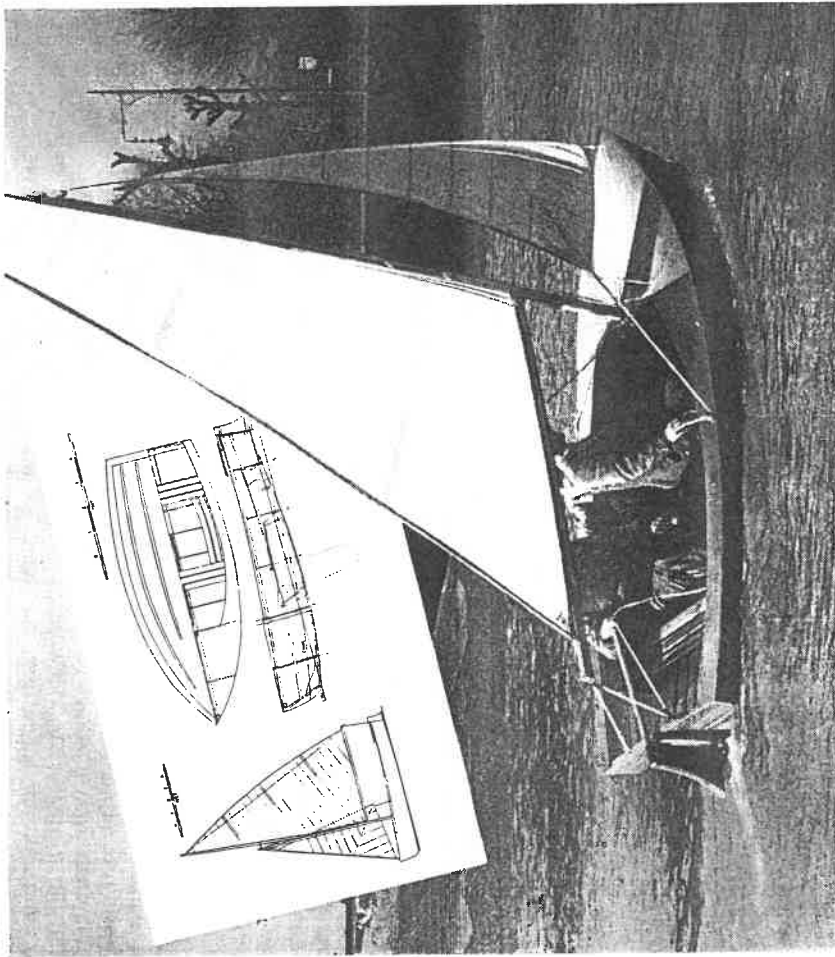

Figure 14.

The shallowest possible vertical and horizontal trenches are cut in gunwales to take the square shoulder of the deck beam. In some cases a slight bevel will be required to the shoulder to conform to the curve of the gunwale but this is very simple as against a compound bevelled dovetail which, unless skilfully fitted, can cause a distortion in the curve of the gunwale. If the simpler method is used and the outside two inches of deck beam is



## Design for Sailing

**YACHTING WORLD** designs for low cost amateur boat building have long been recognised as the finest available. The **CARTOP**, shown above, has been designed by Jack Holt to provide a boat capable of carrying two adults and two children without overloading and yet it can be carried on top of a 10 h.p. car. It is already an established favourite.

Every amateur yachtsman should read "**YACHTING WORLD**," the journal that supplies technical information, practical advice, the latest power and sail news, and regular articles on navigation, pilotage, cruising, racing and seamanship, etc. Order a regular copy from your newsagent.

**CARTOP** - HORNET - CADET - G.P.14 - PEOPLE'S BOAT  
**13ft. OUTBOARD RUNABOUT** - 7ft. 9in. UTILITY PRAM DINGHY - 14ft. DAY BOAT  
**RAMBLER**

by **Yachting World** 2s. 6d monthly

glued when glueing decks to gunwale, a perfectly satisfactory job will result.

Another useful short cut concerns fitting the bottom panel up to the keel. This is called the garboard joint. Normally the required curvature is obtained by spiling off with a compass but we need not go into this. A much easier and quicker method is shown in Figure 15.

Cut the panel roughly to shape and cramp this into position making it touch the side of the keel as closely as possible along the length of the panel wherever it will touch. Using a small block of wood, the thickness of which approximates to the

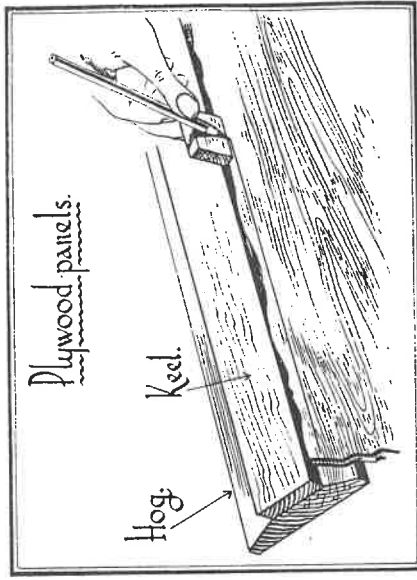

Figure 15.

widest gap between the keel and the panel, mark a line along the panel using a pencil close to the block as shown in the sketch.

If a sharp twist is required at the forward end at the foot of the stem as would be the case in Figure 10 ignore the first few inches when marking for the joint and after trimming the panel along the remaining length, fix it in position temporarily and plane off the forward edge by trial and error to fit closely into position.

Do not worry too much about getting a perfect fit especially forward near the stem as providing joint is well glued it does not matter if a gap up to  $\frac{1}{8}$ " is shown, gap can be filled with stopper in the painting process.

If the dinghy is fully decked the forward panels should be fitted first, side panels next and after panels, if any, last. A simple mitre joint as shown in Figure 16 is the neatest way of joining panels.

If the deck beams are too thin for this method to be adopted, screw and glue a "plant" piece to

the boat. Incidentally it is interesting to know that before a lifeboat of the R.N.L.I. is handed over, or after repairs to one of these craft are approved, it is inspected and one of the points taken care of is that all screw head slots are settled in line, where they occur in rows, and are all tightened down.

The remaining work, especially as far as our kits are concerned, is straight forward enough, but a few observations on fittings may be useful to those who have not had experience of this before.

For small craft never use galvanised screws and fittings if brass is available. Always be sure the fitting is secured sufficiently to stand the strain imposed, for example, chain plates should not have to rely on screw fastenings alone, but should have at least one through fastening (nut and bolt). Use raised head screws if obtainable in conjunction with fittings. Lightweight blocks made from Tufnol,

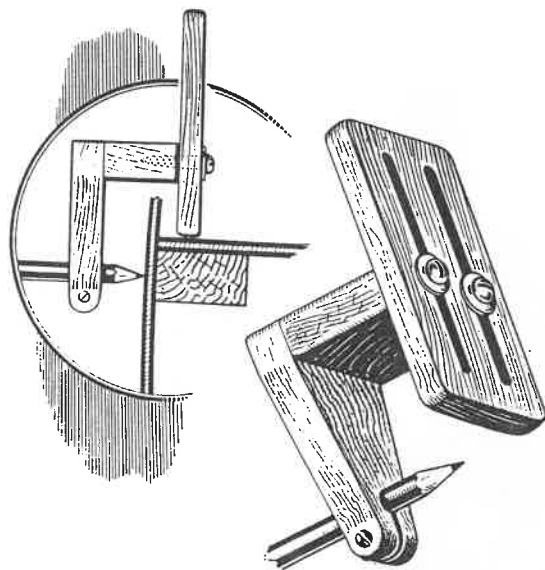
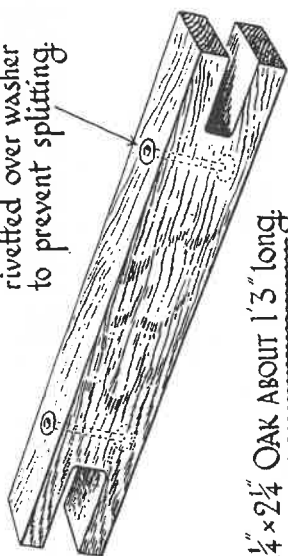

Figure 19.

although somewhat dearer, are ideal for small boats. Being light in weight, little damage is done when they fall on deck. They are made to stand two or three times the strain imposed and the best point about them is that grease or water will act as a lubricant. Details of these blocks appear elsewhere.

Although most brass fittings offered by us are polished, give them a good clean just before varnishing, better still leave them unvarnished and polish them periodically.

Nail or  $\frac{1}{8}$  brass rod rivetted over washer to prevent splitting.



$1\frac{1}{4} \times 2\frac{1}{4}$  OAK ABOUT 1'3" long.

Figure 17.

On varnished surfaces and fittings where screw heads will be seen always arrange for screw head slots to finish in line with the grain of the timber. Not only is this arrangement pleasing to the eye (especially the discerning eye) but it is much better for varnishing and rubbing down when cleaning

TIMBER STRAIGHT GRAINED OAK or ASH.

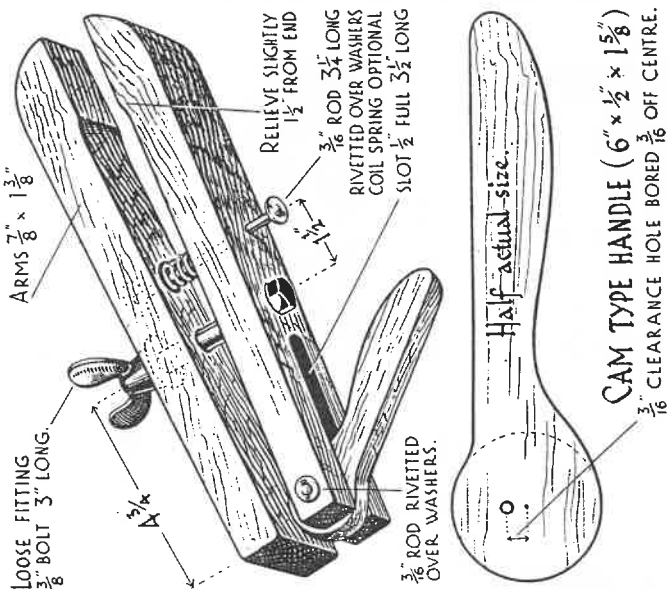

Figure 18.

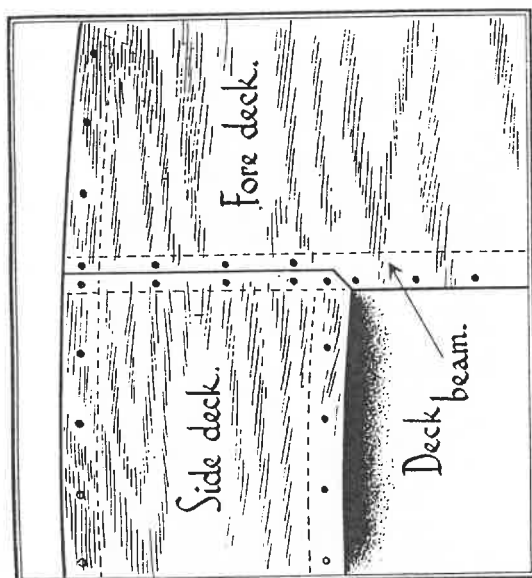

Figure 16.

the side of the beam so increasing its width where ever required.

Chines and gunwales sometimes require twisting and bending at the same time. A simple and very effective wooden prong can easily be made for this purpose. It is illustrated in Figure 17.

Cut a slot in one end of the hardwood prong to suit the chine and another in the opposite end to fit the gunwale unless both are of the same thickness. Using this prong as a lever the gunwale may be given any normal twist and held in position by cramping the prong to the frame while the gunwale is screwed and glued into position.

Another useful tool is a quick release clamp which can be made by following the directions in Figure 18. This one is suitable for cramping up to two inch timbers.

The simple adjustable marking gauge shown in Figure 19 is well worth while making too. This enables one to mark over irregular edges as shown in the inset to Figure 19 a frequent requirement in planking and decking a plywood boat.

A piece of quarter inch plywood slotted to take eight gauge round headed screws forms an adjustable slide. Two small hardwood blocks a half or five-eighths of an inch in thickness are needed to complete the gauge. Small washers should be used under the screw heads to prevent them biting into the timber.



**CENTREBOARDS**

The heavy metal centreplate is rapidly being replaced by timber or plywood centreboards. The metal type being very heavy requires complicated block and tackle involving three or four blocks, two jaming cleats and fathoms of rope to provide easy adjustment. Constant adjustment is required to sail the boat to the best advantage.

Wooden centreboards are just the opposite being light in weight and needing no tackle at all, except some form of friction device to keep them down. Most of the designs offered by us incorporate centreboards and these are sent out ready to fit with friction device already fitted. Two methods of friction are used:—

1. Kautex Pads—these should be carefully sandpapered down until they fit fairly tightly in the centreboard case. Soap rubbed into the face of the pads helps the tight board to work smoothly until it "beds" down.

2. Adjustable rubber hose as shown in Figure 20. Tighten the screws until the right amount of tension is obtained, a small wooden button (marked A) is glued to both faces to take up excessive play in the case. Marked B in the photograph is a tapped brass strip let into the board.

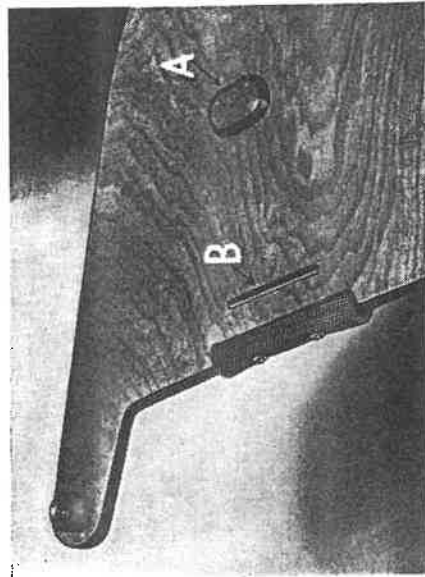

Fig. 20.—A friction method of maintaining and adjusting a wooden centreplate in any desired position.

Whilst on the subject of centreboard cases it must be realised that the normal half-round protective brass keel band must part and go round the

sides of the centreboard slot in the keel. One method is to stop the keel band at the slot and fix separate pieces on either side. This and other methods invariably leave exposed ends to catch on any small obstacles when the boat is being hauled about, tending to pull out the keelband fixing screws. To overcome this we supply (where possible) separate castings to suit the keelband used. Figure 21 shows how this Y piece junction is fitted.

**Retractable or Lifting Rudders**

These are rudders so arranged to allow the rudder blade to lift up on a pivot in line with the keel and the main advantage is that the rudder can be shipped before the craft is launched from a beach and the rudder blade pulled down into position when in sufficient depth of water. Thus the vessel comes under the helmsman's control more quickly and easily. Again when the boat runs aground the rudder and centreplate can both be released so the craft will float away. It is often found that in light weather the reduced area of water friction presented by the raised plate is an advantage among a keen racing fleet.

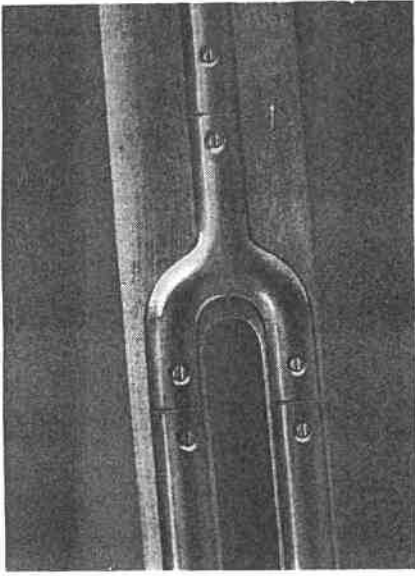

Fig. 21.—Y fitting to take the keelband round the centreboard case.

Figure 22 shows a typical lifting rudder in the up and down positions. A length of elastic cord terminating in a loop is so arranged to allow the blade to be forced up if necessary. Sufficient tension must be maintained to keep the blade down in a seaway. For this reason it is better to disengage the cord when launching and coming ashore. The photograph shows an all-elastic cord but a light line - cum - elastic cord is sometimes better.

When assembling these rudders, pivot the blade on one cheek only in order to check the correct position. Drill the hole in the cheek as indicated. Assemble both cheeks and drill the second hole by using the first as a guide. Where possible arrange for the brass pivot pin to pass through the bottom fitting also.

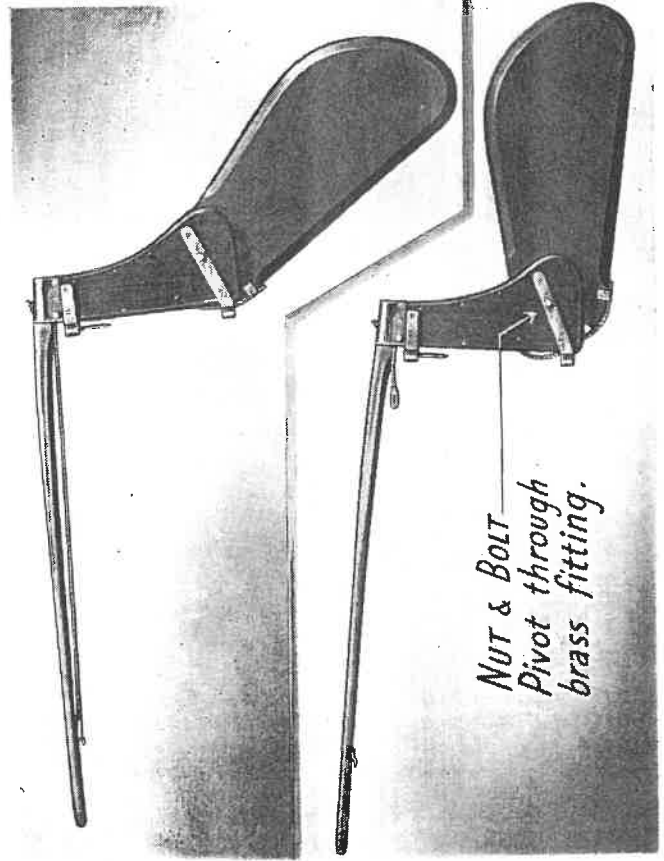

Fig. 22.—A lifting rudder shown in both up and down positions and controlled by an all elastic cord.

## The Power Installation

Before leaving the problems of construction it is just as well to give a little consideration to the installation of an inboard motor involving as it does, the creation of a "watertight hole" in the bottom of the craft we have been at such pains to ensure has a sound skin.

This is rather a difficult problem and the amateur builder is recommended to read a good book on this subject before attempting the fitting.

Installation plans, involving the fitting of tanks for petrol or paraffin, and electrical wiring are always available from the engine manufacturer but two queries invariably arise. The first involves the arrangement of remote steering control and the second the boring for an accurate stern tube for the propeller shaft (our "watertight hole").

Well designed rudder gear is essential. It should be robust, light and handle freely and because of this we have designed and manufacture a first class set of machined parts in brass for the external rudder. This is shown in Figure 23. The steering is carried from the tiller arm by flexible cables working in boxed sheaves, the shells of which are so designed that any angle of entry and exit can be arranged. These are shown in Figure 25. Single screw, centre hole fixing allows the blocks to be mounted at any angle.

The simple diagram in Figure 25 shows the principle of this arrangement though the positioning of this can be varied to install the wheel wherever it is desired.

### Boring for the stern tube

In boring for the stern tube it is very important to lay off the shaft angle with the utmost care. The best angle for both engine and propeller will be indicated by the manufacturer, but of course, the design of the boat has an important effect on just how near one can get to this ideal arrangement.

Normal procedure is to carefully lay off the shaft angle and rig up a temporary jig to guide an auger for drilling a pilot hole. Into this is placed a tapped boring bar carrying the boring bit working on a tapped plate.

Boring and alignment, however, can be made very simple on small cruisers by fitting a "Stuart" Adjustable Metal Shaft Log. This permits one to bore well over size with an ordinary auger as is shown in Figure 24, and obviates the fitting of a permanent deadwood on the hog to carry the inboard bearing.

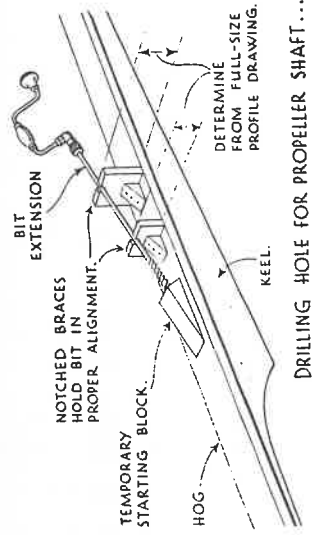

Fig. 24.—Arrangement for boring for stern tube.

Used in conjunction with a strong "A" bracket, this adjustable shaft log makes an ideal tail shaft installation for small cruisers and "runabouts." The arrangement is shown in Figure 26. This bearing can be locked in the correct position whilst the propeller shaft is turning, a feature of the installation that allows a small margin of error in boring.

Further instructions and relevant details are shown in the plans issued with each kit we supply.

### Watertight Porthole and Windscreen Fittings

One of the detractions of a cabin cruiser is the difficulty of keeping moisture out of fittings, bedding, settees and so forth, and one of the most pernicious sources of water seepage has always proved to be the portholes and cabin side lights.

One of the most successful ways of overcoming this that has been found in recent years is the rubber, self-sealing strip. This consists of a round or oval strip of rubber with deep slots cut on opposite sides to take, on the one side, the glass and on the opposite side the wood. These are deep enough to ensure a water-tight fit, which is further ensured by a filling piece of rubber which is inserted in a shaped channel in the rubber so forcing the main strip out towards the glass and wood. This is shown in Figure 27.

The main part of the rubber strip is first fitted round the window panel, the edge of the panel being pressed well into the rubber. Don't cut off

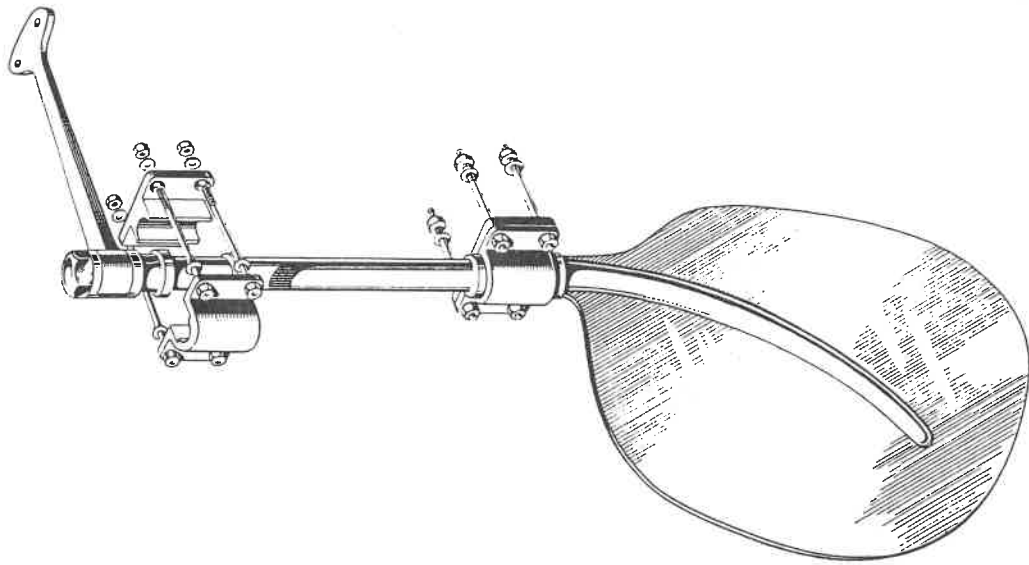

Figure 23.

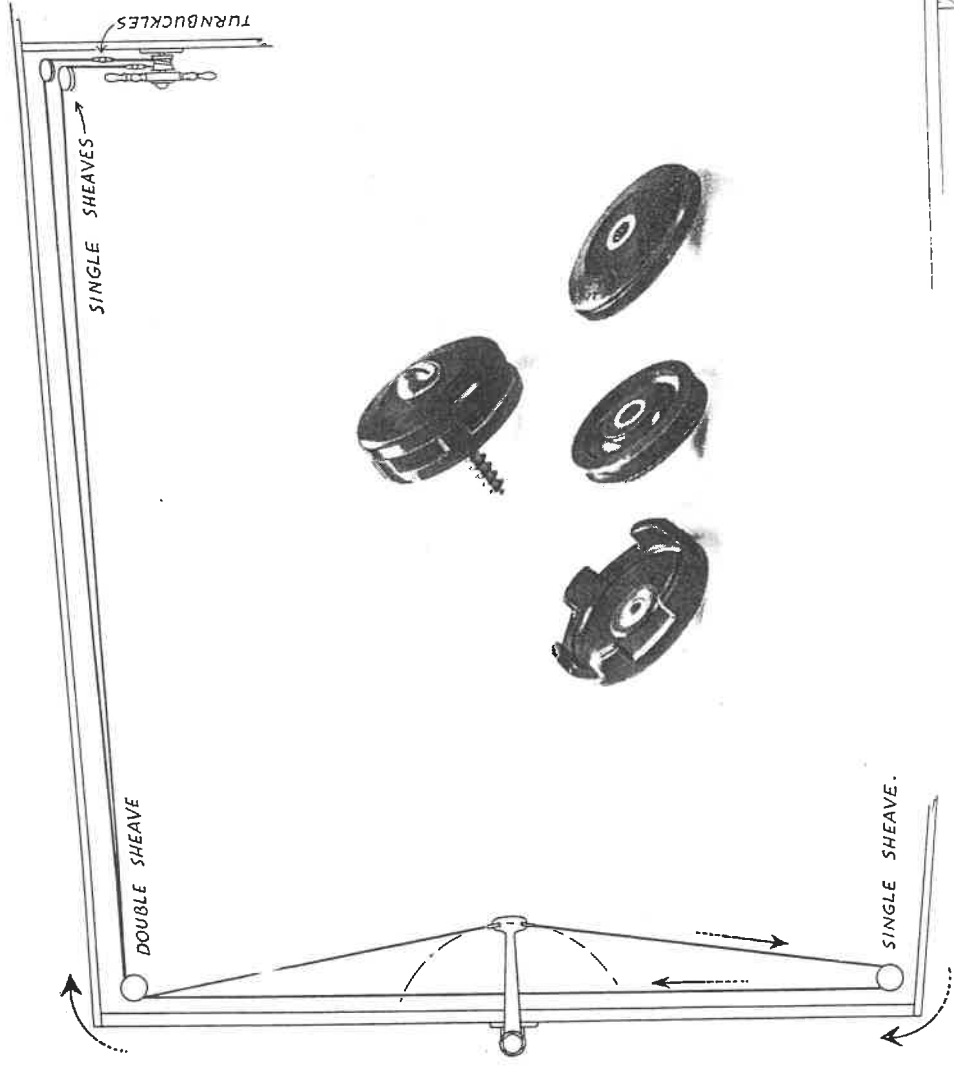

Fig. 25 (Above).—General arrangement of remote control steering with special boxed sheaves shown in inset.

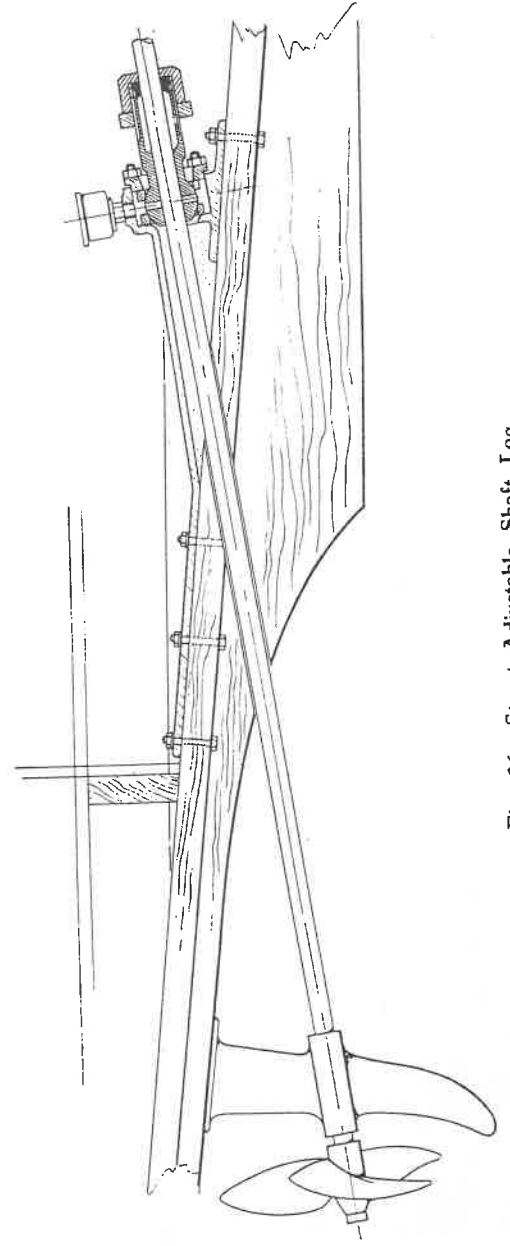

Fig. 26.—Stuart Adjustable Shaft Log.

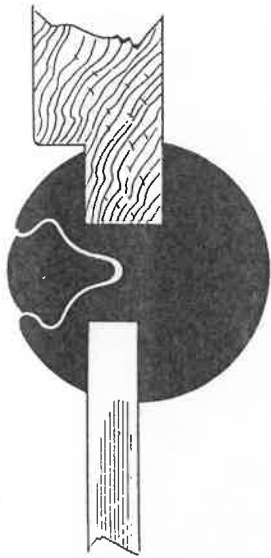

Fig. 27.—A sectional drawing of the self-sealing rubber strip.

the strip until a very close fit is ensured by actual trial and make sure the joint will be at the top of the window. A special tool is supplied to enable the glass or perspex to be pressed into the opposite section in the rubber. It is best to lubricate the edges of the glass slightly with a solution of soap and water. Ensure a snug fit all round the glass. Finally, still using the tool, and lubricating the filling channel in the same way, press home the filler strip, cutting off the filler strip after it has been worked round the whole channel and forcing the ends into the channel so that some compression is applied to the filler, so forcing the rubber outwards against both glass and panel.

#### Bilge Rubbers.

These are protective strips of timber so arranged under the hull to protect the skin when the craft lies aground. They are usually two or three in number on either side of the keel and they should be glued and firmly screwed through the skin and into the frames and well faired off fore and aft.

As with all fittings below water screw holes should be a tight fit to the screw shanks. Position and number of rubbers are usually shown on the plans.

To reduce the skin friction as much as possible it is best to keep the cross section size as small, and shape as streamlined as possible consistent with the required strength.

#### Toe and Kicking Straps

These are two refinements on modern sailing dinghies and often confuse the newcomer to dinghy sailing. Toe straps are lengths of canvas webbing usually fitted on either side of the centreboard case

and so arranged as to allow the crew to lean over the gunwale supported by their toes tucked under the strap. This practice is confined entirely to racing dinghies and a look round other boats of a similar class to your own is the best way of deciding the ideal arrangement for your own use if toe straps are to be fitted.

A kicking strap on the other hand has nothing whatever to do with legs and feet! Its purpose is to prevent the boom rising, or kicking especially when the sheet is freed. Figure 28 shows the usual arrangement. The lanyard should be adjusted so as to allow the boom to swing freely from side to side but tight enough to keep the boom down. A little thought will show that the lower end of a kicking strap must be attached to the mast and never to the top of the centreplate case, otherwise it will immediately act as a supplementary sheet and prevent the free lateral movement of the boom.

A kicking strap can be detached when the

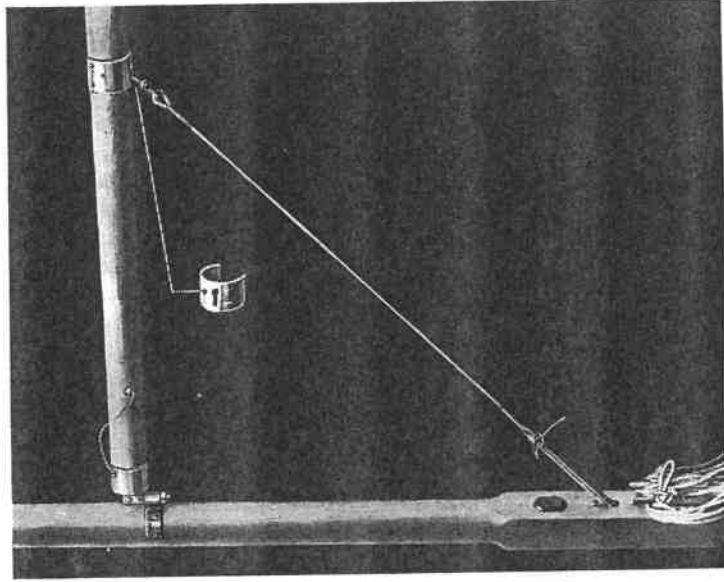

Fig. 28.—The arrangement of a kicking strap with key slot shown as inset.

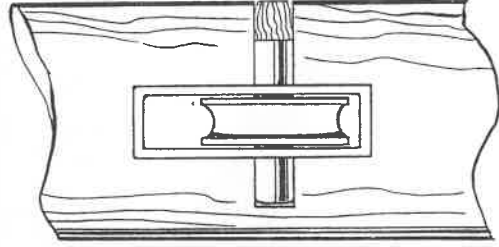

Fig. 29.—A boxed masthead sheave. Note that the wider aperture is uppermost.

dinghy is being sailed close hauled—probably the crew will insist on this in any case—but this can be done because the mainsheet will act as its own kicking strap when it is hauled in. For this purpose a key hole slot fitting is arranged on the underside of the boom to allow the toggle on the strap to be quickly fixed or disengaged.

#### Boxed Masthead Sheaves

There is a decided advantage in fitting a boxed masthead sheave, as anyone who has experienced a main halliard having jumped off its sheave and jambed between the side of this and the worn, bare wood of the mast itself, will realise. The boxed type of sheave becomes more important where the halliards are of the internal type.

The diagram in Figure 29 shows clearly how the sheave is fitted. To save rivetting, brass rod is placed into the hole and forms the spindle for the sheave. This is then secured by gluing a close fitting wooden plug into the aperture. Providing the sheave is kept well greased it should not be necessary to dismantle.

It will be seen that the sheave is fitted asymmetrically in the box since room must be allowed for the halliard to go over the sheave. Care must therefore be taken to see that the larger aperture is nearest the top of the mast.



### Rigging Screws

These are shown in Figure 31 and are an ideal arrangement for tightening up the shrouds and

forestay providing they are kept well oiled and greased. After making the correct adjustment they should be wired to prevent them working loose under the varying strains imposed upon them while sailing. Finally, it is well worth while inserting the shroud or forestay through a length of rubber tubing which can be dropped over the whole of the bottle screw as shown in Figure 31 which shows both the method of wiring the bottle screw and the size of the rubber tube.

The rubber not only protects the fitting from excessive corrosion by seawater (the rigging screws should be kept well greased under the rubber however) but also protects the jib sheets from chafing against split pins used for securing the fixing pins.

When taking the mast down it is only necessary to slack off one shroud rigging screw so that it can be disconnected from the shroud plate when the other two can be disconnected without unwiring and without losing their adjustment, an important point when the time for re-rigging arrives.

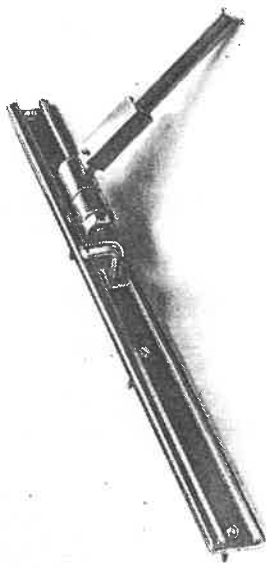

Fig. 30.—The sliding gooseneck.

### The Sliding Gooseneck

The sliding gooseneck is now fitted almost universally among small dinghies. There are two over-riding advantages, the first being that if there is any adjustment permissible on the height of the mainsail luff, and it is possible to hoist the mainsail higher, this can be done where the sliding gooseneck is fitted. The second advantage is in the actual adjustment of tension obtainable in the luff of the mainsail.

When it is realised that most of the mainsail's work in driving the boat is performed by the two or three feet of sail nearest the mast and the correct setting of this part of the sail is almost entirely dependant on the tension in the luff, then this advantage becomes very clear indeed.

A typical sliding gooseneck such as we supply is shown in Figure 30.

The gooseneck is screwed on to the mast in such a way that when the sliding part is at the base of the slide, the boom will be on the lowermost limit permitted, either by the rules of the class (in this case a black band has to be painted round the mast) or by the design. Round headed screws are used at the top and bottom of the slide to prevent the gooseneck slipping out, and countersunk screws in the body of the track. Make sure these are screwed well home and there are no projecting edges on which the gooseneck can jam. It will be prudent to examine these screws on every occasion before launching.

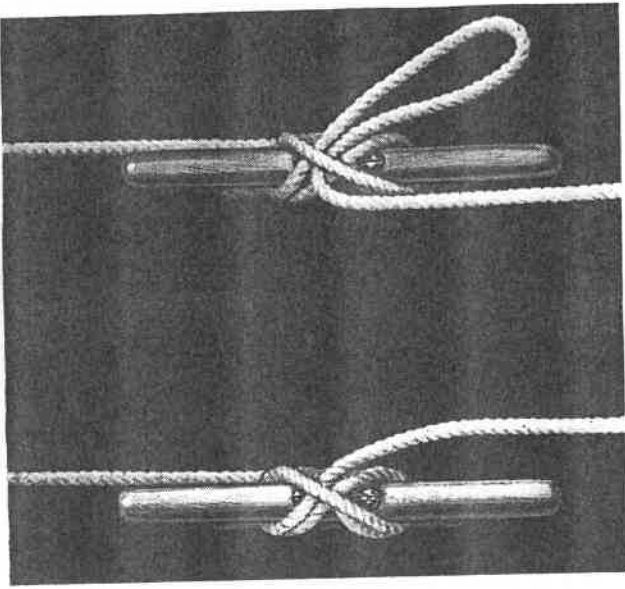

Fig. 32.—Cleating the halyards—usual practice (left) and to prevent jamming (right).

### Cleating Halyards

Figure 32 shows the usual way of making fast the sail halyards, but there are times when the mainsail must be dropped very quickly—in a squall of unusual strength or when approaching the beach—and if the halyard has become wet during sailing it is surprising how tight the half hitch can become. Therefore it is much better to get into the habit of fastening the halyard by means of a slipping hitch as shown in Figure 32 (right). This is especially useful in the case of racing dinghies when

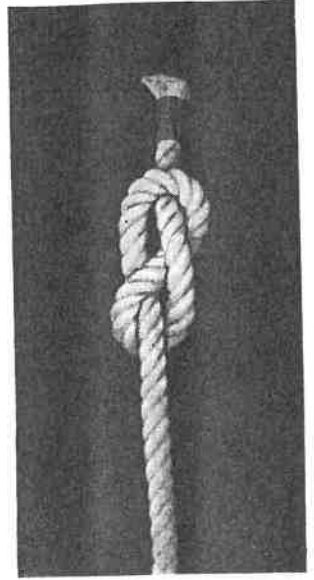

Fig. 33.—A figure of eight knot.

one may be faced with the necessity of pulling down the mainsail when capsized (the halyard is bound to get wet under such circumstances) so that the boat may be righted again quickly.

A "figure of eight" knot should always be tied in the ends of the jib and main sheets to prevent accidental unreeling through sheet blocks or fairleads. Also, the same knot should be tied in the halyard tails especially if these are of the internal kind (see Figure 33).

#### Drain Sockets

These are fitted to dinghies normally kept ashore as an easy means of draining the boat of water, particularly rain water which collects if a boat cover is not used. Ordinary corks are used from the outside for bungs. Drill the bung holes as low as possible on either side of the hog as in Figure 34.

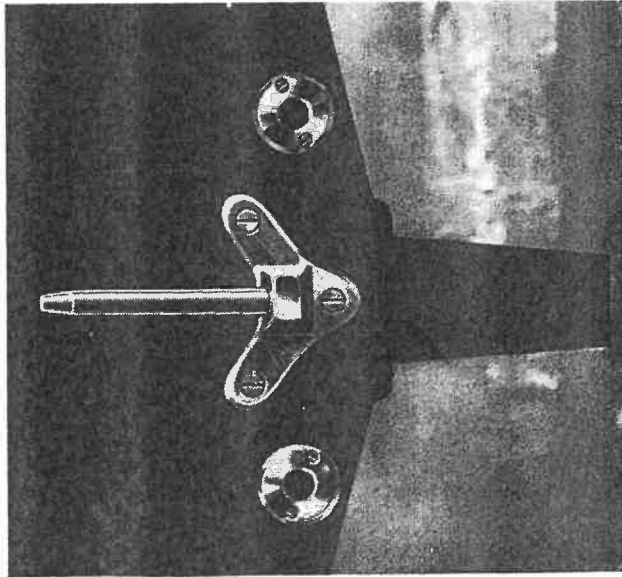

Figure 34.

#### Rowlocks

The sockets for these should be placed between twelve and fourteen inches from the after edge of the rowing thwart.

#### Finishing Off

Before painting bare wood give it a thorough rub down with sandpaper taking care not to sand

against the grain on surfaces to be varnished. Do not start painting unless you have suitable thinners for paints and varnishes. It is a wise policy to employ a very good brush for varnishing and keep this solely for varnish or as it is sometimes called brightwork. When not in use keep the brushes in a jar of thinners.

For painted surfaces brush one coat of pink primer well into the wood and when this is dry fill up joints, screw indentations and any irregularities in the skin with stopper. Rub down all over with dry sandpaper and apply a second coat of pink primer. When dry, check over all the joints and so forth again with stopper and again sandpaper down. The purpose of this is to give a good hard foundation and to fill in the grain of the wood so that the final coat of paint can be built up on a smooth surface.

The next operation therefore is to apply a first coat of colour undercoating and allow it to harden completely. Then use wet or dry (waterproof) sandpaper which is distinguished by the initials WOD, and commence sandpapering the whole surface, dipping the sandpaper into a bucket of water at very frequent intervals. It does not matter if the bare wood appears again since we know that the grain is properly filled, and this is the only way of ensuring a perfectly smooth, even surface. Using water as a lubricant, wipe off all the small particles until the surface is quite clean again and free from dust.

Next, give one more coat of undercoating and use water and WOD sandpaper again to produce a really smooth surface though this time the paint should not be cut down so far. Should, however, any small irregularities still be apparent on the surface it is better to cut away at these and should the bare wood again appear, put on yet another coat of undercoating. In a new craft, however, this is most unlikely to happen, though the tip should be remembered for fitting out in future years.

Wipe all small particles of this second coat and leave it to harden. Unless it is near perfect it is impossible to obtain the final yachting finish and it should be closely inspected after hardening.

Choose a warm dry day for the final coat if possible. Dust is the main enemy of a good enamelled finish and must be ruthlessly eliminated. Sprinkle the floor with water. Exclude the dog at all costs. Bung up all the holes in the room in

which you are working. Send the relations away for the week-end. Wear clothing that is thoroughly brushed out—an old tweed jacket simply will not do because of the hairs that are likely to fall on the work.

Apply the final coat generously, brushing out as far as possible to leave no surplus to start a run. Finish off with light strokes running in the direction of the grain. The secret of the best surfaces is in the rubbing down and painstaking attention to detail in the last coat.

In varnishing, thin down sufficient varnish for the first coat by using one-third thinners to two-thirds varnish and brush this first coat well into the wood. Rub this down very well indeed. At this stage you have two possibilities in creating a finish. In the first you may now apply three coats of varnish allowing each to dry and harden, and rubbing down lightly before the next is applied. A good result will be obtained and for anyone who is not an out and out racing fan, or who likes to see perfection in the finish of a craft, this will be quite sufficient.

Possibly, however, you will wish to emulate in your craft, the very fine results to be seen among the crack National 12s, or even International 14s. There is no reason why this need not be obtained on a hard chine craft, and there is no reason why the well designed craft obtainable here in kits should not look every bit as well as their more expensive sisters.

The enthusiasts who aim to better the french polisher's finish, apply three full coats of varnish over the first thinned coat applied to the wood rubbing down slightly in between each so that there is a good keying surface.

Next they set to work and rub this down using WOD sandpaper, until they are nearly back to the wood again. The purpose of this is to obtain a perfectly smooth surface, eliminating all the very slight bumps and hollows that might be present in the wood.

A fourth coat is then applied and brushed well out. This is given a slight roughing with fine sandpaper and finally a fifth and last coat applied—again well brushed out and with care taken to eliminate all runs. A fine warm day is best for this, and the job should be commenced early in the morning so that there is plenty of time for it to dry before the evening coolness, with its attendant risk of dew and damp.

The result (which depends mostly on the rubbing down) is a mirror finish which, if the boat is hauled out between each race or sail, will last for years there being a necessity only for retouching and one coat per year.

Rubbing down, however, is the secret of both good enamelling and good varnishing. The reason is that the primary coats always have "high spots," slight accumulations of paint or varnish that may have had a slightly thicker consistency, or that might have accumulated round some minor unevenness on the surface, a whisker of wood for example. If these are not sandpapered down the accumulation grows with each successive coat. Do not hesitate to add thinners if the paint or varnish appears too stiff for easy working.

### RUNNING IN THE NEW CRAFT

It is always best to keep a small racing dinghy out of water in some convenient shed, or under a cover to prevent the elements getting at the varnish and skin. The main reason for this is to prevent it accumulating weight by absorbing moisture into the timbers. She may have to be left on moorings, but in this case much greater care will have to be lavished on her throughout her life. Out of water she is under your eye and easily accessible in all parts.

The craft will have been rigged according to the design. You may find that the rigging is rather tight—it may even be too tight. In either case there is room for adjustment at the rigging screws. If the rigging is much too tight it will pay to insert an extra shackle between the bottle screws and the chain plates, for after sailing for a while you will probably find that the rigging stretches quite a lot and it can be tightened up. The shackles may be taken out later.

Make sure that the mast is perfectly square to the waterline, if anything it may be allowed to rake forward a little on some designs but this should be no more than 5° from the vertical if at all. It sometimes happens that a craft goes to windward better with a slight forward rake, but it was only the old gaff rigged craft that were improved by a mast raked aft! There should be a perfectly even tension on the shrouds and this should balance the pull on the forestay. Squint up the mainsail luff track to see if the mast is straight. It is possible to pull it into a snake like curve by too much tension at the hounds and there will be enough strain on these

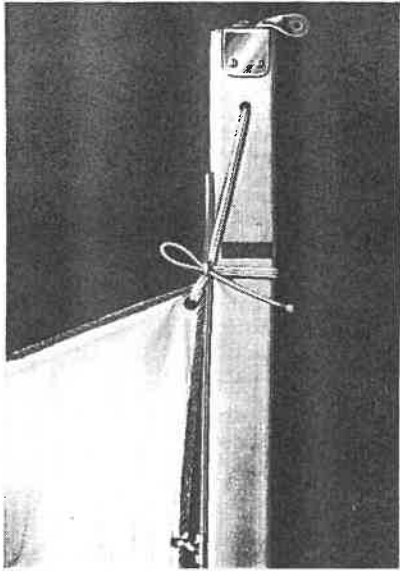

Fig. 35.—Securing the clew of the mainsail.

when the sails are hoisted without over-doing it at this stage. There will probably be some "whip" in the mast when you have finished rigging, but don't worry about this especially if it is occurring in the top mast. This little bit of freedom provides sufficient "give" for the mast to take the shock of a sudden gust of wind.

It is best to hoist the sails on shore before launching as in the case of a small craft, the set and adjustment of the sails means a tremendous amount to the performance.

The care necessary in rigging a craft cannot be believed until you have watched several of the same class of dinghy sail past as though you were anchored—don't think your craft is wrongly constructed if this happens.

First enter the clew of the mainsail into the foot rope groove on the boom, or into the track if this is fitted. Haul it out finger tight, and secure

it in the manner shown in Figure 35. Then enter the luff rope into the mast groove, or on to the track and hoist the mainsail, care being taken to see that the bow of the craft is pointing into the wind. Haul it up finger tight and make sure there are no wrinkles, and no local strains on either the luff or foot ropes. It will be best to examine the mast and boom grooves to see that no varnish has dried in to make a temporary constriction. These may well be sandpapered out before attempting to hoist the sail.

Having made sure that the mainsail is comfortably hoisted—do not try to pull out the wrinkles in the canvas itself, these will work out as the vessel is "run in," which is what we are trying to do now.

The jib will have a wire luff rope so that it may be hauled up quite tightly. Do not allow the sails to flap about too long before getting under way.

You will, of course, have chosen a bright sunny day, which is an ideal condition for sail stretching. If it looks as though a reef is necessary pack up and go home or risk pulling the costly sails out of shape for good and all. At all costs keep the sails dry. If they do get a splash or two of salt water, wash them in fresh water when you have finished and hang them out to dry.

For the first sail drive the boat gently about on a reach, sailing in a figure of eight as shown in Figure 36, which, incidentally is the easiest way for the novice to handle his craft. Don't pin her in and try to go hard to windward. Even though a boat is involved to take the craft out into free sailing water, take her gently, sailing well off the wind.

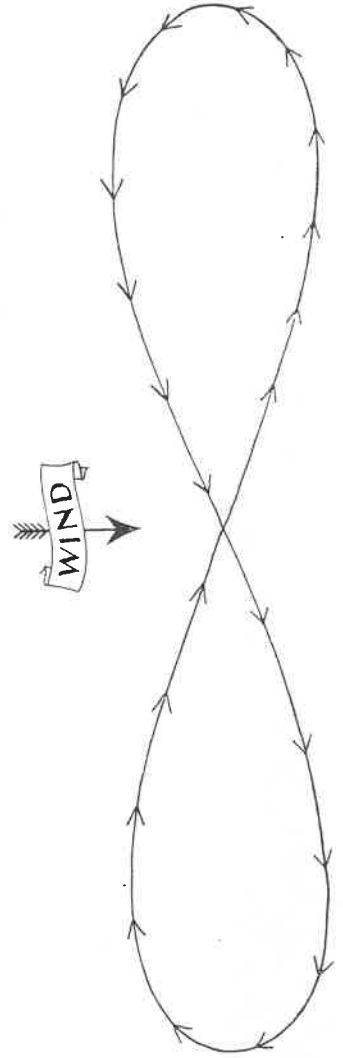

It will quickly be noticed that the luff of the mainsail, and to a certain extent the foot-rope becomes slack. This is because the rope luff and foot stretch more quickly than the canvas and is the reason incidentally, for the wrinkles that were noticeable when the sails were first hoisted. A sail is made like this so that when both canvas and rope are fully stretched they fall equally together and a perfectly setting sail is the result.

The slack in the luff and foot may be taken up at say half hour intervals while sailing. It may be noticed that the boom droops slightly in a most unseamanlike fashion. This is because the leach of the mainsail is not supported by a thick rope like the luff. To pin the boom hard in will cause the leach to stretch disproportionately with the luff and a perpetually drooping boom will result, the sail will be out of shape and working inefficiently for the rest of its life.

It should take six to eight hours of gentle sailing before the sails have settled down and it becomes safe to put rather more heavy strains upon them. Even so it will probably be found that the mast rake might have to be altered and the leads of the sails adjusted. There are endless variations to be tried in this way and the enthusiastic sailor will keep on trying until the best possible performance is obtained from the craft. This is part of the fun of sailing especially when taking part in class racing.

Salt drying into a sail is very bad. It means that the sail is perpetually damp, stretches unevenly when in use and encourages mildew which very quickly destroys the sail. A sail should always be washed out in fresh water and thoroughly dried after sailing. There are several proprietary brands of antimildew solution on the market, however, and some firms will, for a relatively small sum, water-proof the sails and put them through an antimildew process. This is well worth while.

It is better to stow sails loosely in a fairly large bag so that the air can circulate round all the folds in the canvas, again, an anti-mildew precaution.

There is much to be said both for and against coloured sails—perhaps more for the onlooker than the sailor. However, if coloured sails are preferred it is better to start off with them and have them made from coloured canvas rather than to have white sails dyed. In spite of the dyers' guarantees, it has been found that the process does cause some

shrinking and this, though very slight, is enough to give a bad shape.

### Running-in the Motor Cruiser

There is little that can be added to the maker's instructions for the running-in of a powered craft, whether the engine is outboard or inboard. It is a matter of mechanics and if instructions are not available follow good "car practice" and run the engine on about half revs for the first twenty sailing hours, thereafter gradually increasing them up to forty hours, making sure that adequate attention is paid to lubrication throughout this time.

The greatest precaution that has to be paid to a power installation is in the electrics. Great care must be taken to see that they are kept dry of seawater and all exposed parts where it is possible, should be coated with vaseline or grease to prevent corrosion. Of course, the best way of ensuring this is to see that the boat is kept bailed out of fresh as well as seawater—the cockpit provides a lovely catchment area during a storm—and that the bilges are kept dry.

Where Calor Gas is installed in a cabin cruiser, make sure that when not in use, the gas is turned off at the tank and pay particular attention to the pipe leads from the tank to the stove and lights. Make sure there are no kinks in the pipe or any loose object near that might be thrown against them and break them in a seaway. Check on any joints that might work loose, at frequent intervals. A handy stove to have aboard a cabin cruiser is

### BIBLIOGRAPHY

Below we suggest a few books that will help you in maintenance and using your craft. Of course, there are several important yachting and sailing journals on the market, each catering for some particular aspect of the game. Your newsagent will be able to help in the choice of the one most suitable.

#### Construction and Maintenance

Every Man His Own Shipwright James I. Bell  
Racing Dinghy Maintenance Ian Proctor  
Motor Yachting A. M. Kinnersley Saul

#### Handling and Cruising

The Young Sailor Guy Pennant  
Racing Dinghy Handling Ian Proctor  
Scientific Sailboat Racing Ted Wells  
How to Sail John Fisher  
Dinghy Cruising A. G. Earle

What to do on the Norfolk Broads

Motor Cruising on the Thames Geoffrey Essenn

Teach Yourself Motor Boating

one fitted in gimbals so that a cup of hot tea or soup can be prepared at any time, no matter what the motion of the ship.

Finally aboard a cabin cruiser keep the cabin and lockers as well ventilated as possible. Never leave her with ventilators screwed tight down and when coming aboard open all the cabin portholes and skylights so that fresh air can quickly permeate to every part of the vessel.

\* \* \*

We have tried to give you all the help we can in looking after your craft. In the remaining pages of this book we offer you a choice of tested and proved designs of all types of vessel. Some of them have reached hundreds in numbers and classes have been formed with Owners' Associations, Class Rules, Championship events and so on.

Whether you prefer the arduous exertions of racing, or the quiet enjoyment of a motor cruiser, you can buy them in parts, as bare hulls or as completed craft and the tips and instructions we have given you here, and the instructions that are included in every set of parts will enable you to build a first-class boat, without much difficulty from one of our kits.

However, should you be in doubt about any of the constructional details please do not hesitate to write as our interest does not end with the banking of your cheque. You can always telephone us in the evening when calls are cheaper, at Wigston 2524.

Good luck and happy sailing.

Chantry Publications  
Robert Ross  
The Bodley Head

A. & C. Black  
Robert Ross  
Stanford  
Eyre & Spottiswoode  
Peter Davies  
Jarrollds

Robert Ross  
English University Press



# Blandford-Bell 15 ft. All purpose Canvas-Covered Canoe

Designed by  
Percy W. Blair

A canvas-covered canoe is one of the simplest and cheapest craft to build, yet it is surprisingly seaworthy and easily transported or stored. This canoe will carry two adults with all their camping kit, yet it is easily paddled single-handed by a boy or girl.

It will float in 4 in. of water, so can be used for exploring the smallest streams and because of its portability it can be taken on water inaccessible to other craft. It is designed to carry a normal load of about 500 lb. yet it is light enough for one person to carry unaided around locks, unshoatable rivers or rapids, or other obstructions. It will travel comfortably on the roof of the smallest car or on a pair of wheels behind a bicycle. It may be sent about the country very cheaply by rail. A truly go-anywhere craft!

The canoe is normally propelled by double-bladed paddles. The technique is easily mastered after a few minutes practice and is much easier and pleasanter than rowing—you see where you are going, instead of where you are coming from. A pair of experienced paddlers can easily cover 25 miles in a day.

Once the beginner has learnt to handle his craft on sheltered water he can progress to more ambitious water as he gains experience. The canoe is suitable for shooting rapids and weirs—a holiday on a natural river, such as the Wye with its occasional rapid and the unspoiled scenery, will long be remembered. With its great stability, this canoe is also suitable for use on the open sea, and can be used for extensive coastal or cross-Channel cruising in experienced hands.

Besides paddling, the canoe may be power-driven, by fitting an outboard motor to a cross-bar at the back of the cockpit. We recommend the British Anzani "Minor", which will drive the canoe faster than it can be paddled. A motor at one side does not tip the canoe, as the thrust from the propeller keeps the craft on an even keel. Under power, the canoe is steered by a foot-operated rudder.

Complete sailing gear is also available as an extra kit. While a paddling canoe converted to sail cannot be expected to rival a class sailing dinghy, the addition of sailing gear gives increased enjoyment as you use the wind to glide over the water. The rig provided includes a sloop sail plan with a fore sail and a quarter main sail with the mast, spars and rigging. Keel surface is provided by adjustable leeboards and steering is by a foot-operated rudder.

The structure of the canoe is so simple that a boy or girl may build it. There are no awkward joints to cut and there is none of the "fairing in" of the wooden-skinned dinghy. The only tools needed will be found in most households.

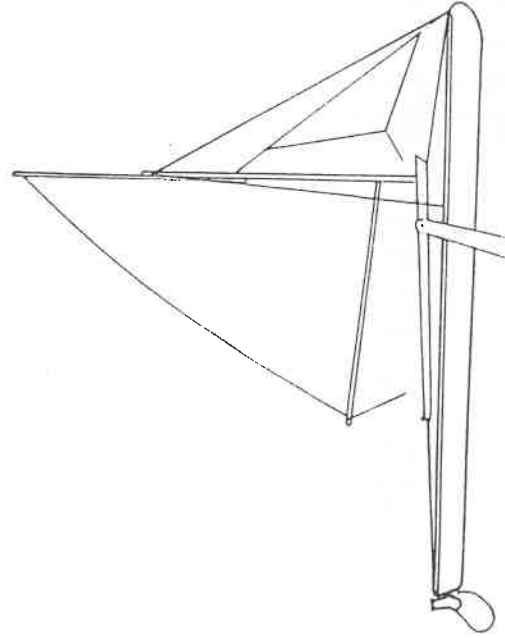

The wood and metal parts are supplied finished as far as possible. Everything is done to ensure the parts fitting together correctly so that each canoe is built exactly as designed. The frames arrive finished, and construction is started by fitting them to a hog piece which is already grooved to give the correct location for each frame. From this point the canoe takes shape rapidly—much quicker than a dinghy. Every step is illustrated and described in the instructions and drawings which accompany the kit. The work follows smoothly up to the fitting of the mahogany coaming, which is already shaped and its raking mitre already cut.

A choice of skin materials is available. A fabric hull and deck are easily fitted. Their strength is surprising. Many times in rough-water cruises canvas-covered canoes have hit rocks so hard that parts of the wooden framework have cracked, yet the skin has remained undamaged. If the skin does puncture, it is easily and quickly patched.

The kit provides many extras so that the canoe may be given a first-class finish. There are brass plates shaped to fit around the corners of the cockpit coaming. Hooks are provided to keep the bow and stern painters neatly coiled on the deck. Two paddle brackets come ready to bolt on. There are shaped brass end pieces to cover and protect the bow and stern, and to provide secure fastenings for the painters or for lashing on the roof of the craft. The back-rest parts are already shaped to a comfortable curve. The mounting for the motor bracket is included.

All of this adds up to a shapely and beautiful canoe of which you will be justly proud—a craft which will hold its own against any other canoe—designed by a specialist with a world-wide reputation.

Kit of all wooden parts, complete with plans, building instructions, glue, brass fittings and screws, as illustrated, £12/5/0d. ex works, packing and passenger train carriage 15/- extra. Frames and end posts are sent out fully shaped and machined from highest grade Mahogany marine plywood (BSS1088—AX100).

Self centring frames and end parts ready to set up on self-spacing tapered hog.

(Note: It is much cheaper to buy a complete kit than the various separate items which are sometimes offered).

<b>Canoe Skin.</b>	92/-
Sufficient rubberised canvas for hull only .....	
This is silver one side and does not require painting.	
12 oz. Shrank canvas, var dyed, 3/4" wide, for decks. Length required 15' 6" .....	45/-
1/2 pint can of Bostik "C" Adhesive .....	3/9
1/2 lb. Copper tacks .....	3/6

<b>Seats (locker type)</b>	19/-
Made up and varnished ready for use .....	
<b>Outboard Motor Bracket, complete with bolts and varnished ready for use</b> .....	20/-

<b>Rudder Gear.</b>	30/-
Complete rudder, varnished with plastic, lines and struts .....	

Sails, etc.  
Job and Mainsail, with mast, boom and gaff, together with all rigging and fittings, ready for use, also Leeboard and Cross Piece .....

**Paddles.**  
Double-bladed Silver Spruce, with centre rib and drip rings ... £2/7/6

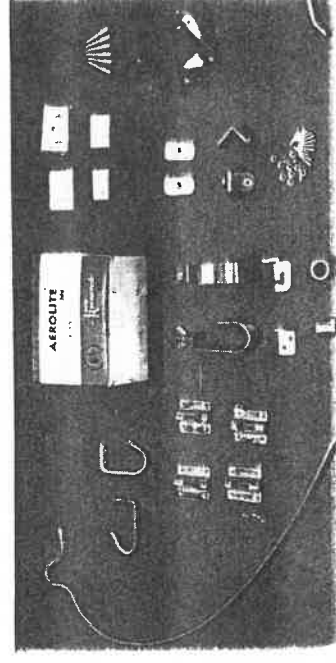
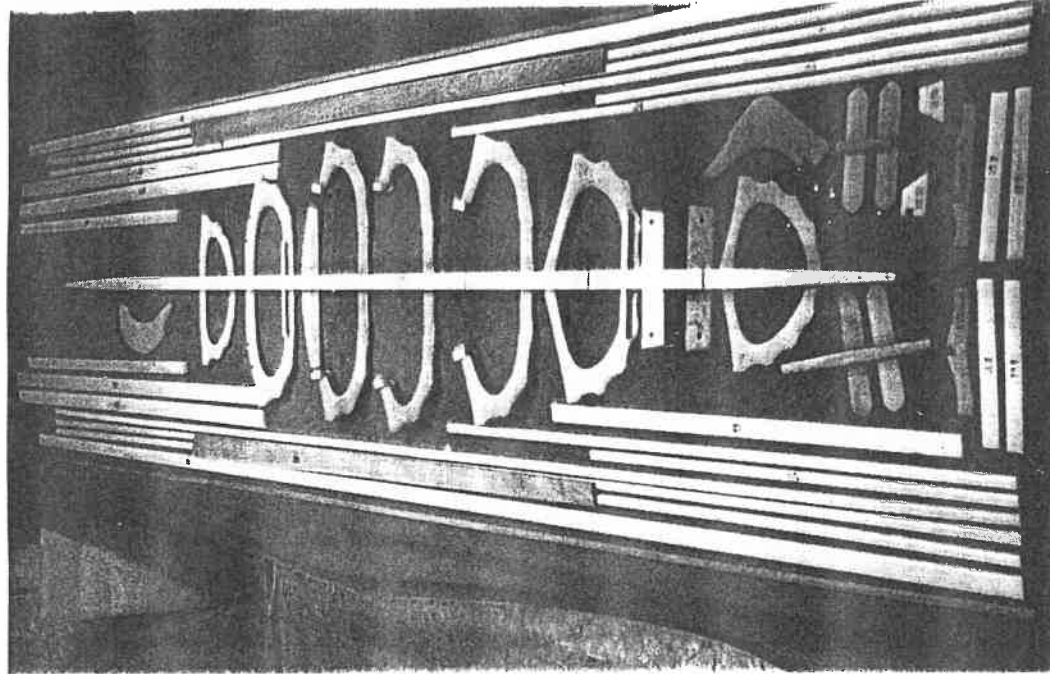

# LAKE PLYWOOD - SHEET BLOCKS - GLUES - PAINTS

TAKE APART DINGHY BLOCKS IN LAMINATED PLASTIC

## PLYWOOD

Made to B.S. Specification 1088

Phenolic glued to AX 100 Test

$\frac{1}{4}$ ",  $\frac{5}{16}$ ",  $\frac{3}{8}$ ", &  $\frac{1}{2}$ " in sheets of logany throughout. Sizes up to 96" x 48" (maximum).

.....	1/6 per sq. ft.
.....	1/9 " "
.....	2/3 " "
.....	2/9 " "
.....	3/6 " "

## OARS (Straight Bladed)

Unvarnished in Sitka Spruce

"	.....	40/- per pair
"	.....	42/6 " "
"	.....	45/- " "
ishing (extra) ...	4/-	" "
ering (extra) .....	2/6	" "
hering (extra) ...	7/6	" "
riage & Packing (extra)	5/-	" "

## PADDLES in Sitka Spruce

" Plain .....	11/- each
" .....	12/6 each
" Varnished .....	13/6 each
" .....	15/- each
" Plywood Bladed—	
Painted Aluminium	7/6 each
ble bladed with centre	
rib and drip rings	45/- each

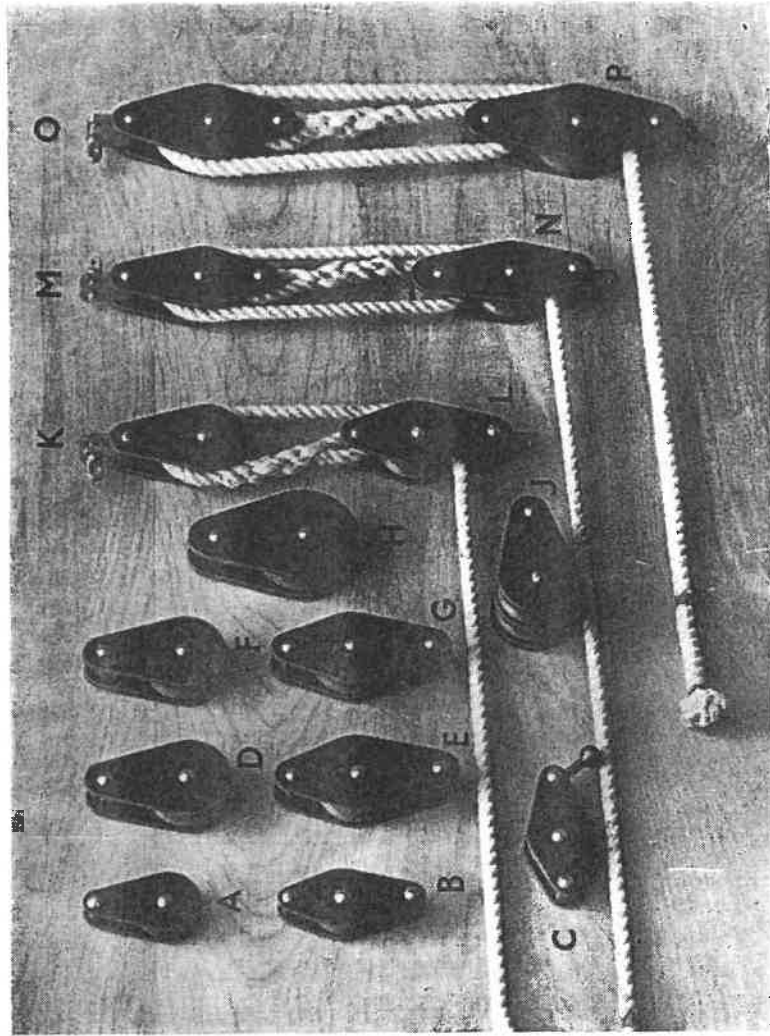

## GENERAL PURPOSE BLOCKS

A. 3/32" Cheeks,	$\frac{3}{8}$ " x $1\frac{1}{4}$ "	diameter sheaves for rope up to 1" circ.	...	3	9
B. 3/32" "	$\frac{3}{8}$ " x $1\frac{1}{4}$ "	" "	...	4	0
C. 3/32" "	$\frac{3}{8}$ " x $1\frac{1}{4}$ "	" (for use with keyhole plate)	...	6	3
D. 3/32" "	$\frac{1}{2}$ " x $1\frac{1}{4}$ "	for rope up to $1\frac{1}{2}$ " circ.	...	5	0
E. 3/32" "	$\frac{1}{2}$ " x $1\frac{1}{4}$ "	" "	...	5	3
F. 1/8" "	$\frac{1}{2}$ " x $1\frac{1}{4}$ "	" "	...	6	0
G. 1/8" "	$\frac{1}{2}$ " x $1\frac{1}{4}$ "	" "	...	6	3
H. 1/8" "	$\frac{1}{2}$ " x $2\frac{1}{4}$ "	" "	...	7	0
J. 1/8" "	$\frac{1}{2}$ " x $1\frac{1}{4}$ "	twin sheaves	...	11	0

## SHEET BLOCKS

K. 3/32" Cheeks,	$1\frac{1}{2}$ " x $1\frac{1}{4}$ "	diameter sheaves for rope up to 1" circ.	...	9	0
L. 3/32" "	$1\frac{1}{2}$ " x $1\frac{1}{4}$ "	" "	...	8	3
M. 1/8" "	$1\frac{1}{2}$ " x $1\frac{1}{4}$ "	" "	...	11	0
N. 1/8" "	$1\frac{1}{2}$ " x $1\frac{1}{4}$ "	(Fiddle Block 1" diam.)	...	11	6
O. 1/8" "	$1\frac{1}{2}$ " x $1\frac{1}{4}$ "	sheaves for rope up to $1\frac{1}{2}$ " circ.	...	12	0
P. 1/8" "	$1\frac{1}{2}$ " x $1\frac{1}{4}$ "	(Fiddle Block $1\frac{1}{2}$ " diam.)	...	13	0

The Blocks are extremely strong, for instance, Sheet Blocks K & L intended for 12' dinghies, with an average working load of 350 lbs. are tested to a breaking strain of 1,170 lbs., and blocks with  $\frac{3}{8}$ " cheeks tested to 1,400 lbs.

## PAINTS

Topside Enamels ..... per pint 9 6  
Undercoatings for above

per quart 14 0  
Pink Primer ..... per quart 14 0  
Best Quality Yacht Varnish  
per half-pint 4 0  
per pint 6 9  
per quart 12 9  
half-gall 24 9

Marine Thinner for use  
with above ..... per pint 3 0  
per quart 5 6

White Stopper ..... per lb. tin...2 3  
Carriage and Packing 10% extra  
Minimum 2/-

A Shade Card will be sent on request.

## GLUE

Aerolite 300 liquid glue ... 4/6 per lb.  
Clear Hardener for above 4/6 per lb.  
Aerolite 306 powder ..... 6/- per lb.  
When ordering glue add 2/- per order for postage and special packing.

BOSTIK "D" Adhesive 3/- per  $\frac{1}{2}$  pint tin.

PRESTIK TAPE. 1" Red 6d. per ft.

## COPPER BOAT NAILS

7/- per lb.

# FITTINGS - RIGGING - TROLLEYS - BOAT COVERS

## FITTINGS

Anchors. 4½ lb. Galvanised Stockless Anchor	...	...	...	£1	5	0
" Fisherman Anchor	...	...	...	...	17	6
Cleats. 6" Ash Cleats for light halyards, each	...	...	...	...	1	6
Polished Gunmetal Jamb Cleats, each	...	...	...	...	4	6
"Cam" type Tufnol Jamb Cleats for use with fairleads, pair	...	...	...	£1	4	6
3" Pol. G.M. Mooring Cleats, each	...	...	...	...	3	6
4" " " "	...	...	...	...	5	0
6" " " "	...	...	...	...	6	6
Fairleads. Bulls Eye Fairleads with lignum vitae bushes, brass plates and threaded U bolt attachment for use with rope up to 1½" circ., pair	...	...	...	...	10	0
Pol. G.M. Bow Fairleads, Port or Starboard, 3", each	...	...	...	...	3	6
" " " "	...	...	...	...	4	6
" " " "	...	...	...	...	15	6
Goosenecks. In Brass for 2" diameter mast, each	...	...	...	...	16	6
" In Brass for 2½" diameter mast, each	...	...	...	...	1	0
Sliding Gooseneck in Brass, mounted on 12" track, each	...	...	...	£1	1	3
External type Brass Mast Track, c/w fixing screws, per ft.	...	...	...	...	9	9
Sail slides for above, each	...	...	...	...	2	6
Deck Handles. In Brass with two fixing holes each end, each	...	...	...	...	2	6
" In Mahogany with brass fixing bolts and screws, each	...	...	...	...	1	9
Yacht Quality "D" and Harp Shackles 1½" & 1" M/Bronze, or galvanised each	...	...	...	...	3	0
Small Brass Snap Shackles	...	...	...	...	7	6
Brass Piston Hanks, each	...	...	...	...	17	6
Brass Flanged Drainsockets with fixing screws, per pair	...	...	...	...	£3	15
Galvanised Iron Rowlocks with Brass Plates, per pair	...	...	...	...	1	3
Gunmetal Rowlocks and Plates, per pair	...	...	...	...	1	6
Chromium Plated Bilge Pumps, each	...	...	...	...	1	8
Tufnol Sheaves. 1" x 1½" x 1" bore, each	...	...	...	...	2	3
" 1½" x 2" x 1½" "	...	...	...	...	1	8
" 2" x 2½" x 2" "	...	...	...	...	2	9
" 1" x 1½" x 1" "	...	...	...	...	3	6
" 1½" x 2" x 1½" "	...	...	...	...	8	6
" 2½" x 3" x 2½" "	...	...	...	...	5	0
Rigging Screws. 20 cwt., all bronze	...	...	...	...	4	6
15 cwt. brass with galv. fork and eye ends	...	...	...	...	1	0
10 cwt. brass with galv. fork and eye ends	...	...	...	...	1	0
5 cwt. brass rigging screws with two eye ends	...	...	...	£1	11	6
Pol. G.M. Mushroom Ventilators, each	...	...	...	£4	10	0
Pol. G.M. Steering Wheel with hardwood drum (6 handles), each	...	...	...	...	1	6
Sail Battens, in plastic, 1½" x 3/32", per ft.	...	...	...	...	1	0
Sail Battens, in Timber, per foot	...	...	...	...	1	0
Kautex Friction Pads for centreboards, per pair	...	...	...	...	5	0

Other fittings may be selected from lists given for our range of boats and can be supplied separately at list prices plus 5% to cover packing and carriage. Unless otherwise stated all fittings are in brass or gunmetal and fixing screws or bolts are included into prices shown. Where items can be posted add 2/- for postage and packing otherwise add 5% shewn.

## RIGGING

White Cotton Rope. ½" circ.	...	...	...	3d.	per yard
1" circ.	...	...	...	9d.	per yard
1½" circ.	...	...	...	10d.	per yard
2" circ.	...	...	...	11d.	per yard
Lanyard Rope in Italian Hemp	...	...	...	8/-	per 30 fm.
3/8" circ. Italian Hemp, Dressed and polished.	...	...	...	6d.	per yard
very hard laid	...	...	...	6d.	per yard
Stainless Steel Piano Wire	...	...	...	...	...

We can undertake to supply special rigging, wire and rope splicing and rope splicing, also complete sets of rigging for dinghies up to 18' long details including strength of rigging screws, etc., should be given for our purposes.

**Sensitive Racing Flags 13/6 each**

## FENDOFFS

Sorbo rubber, ex-Government Stock, canvas covered with lanyard:	...	...	...	8	3	each
8" x 4"	...	...	...	10	6	each
9" x 5"	...	...	...	...	...	...

## HUNT Launching Trolley

£8/15/0 delivered.

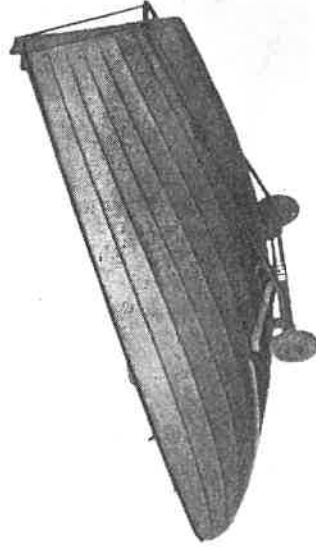

These trolleys are of welded steel construction with Pneumatic wheels. They obviate the necessity for more than two people to launch transport. It is normal practice for dinghies to be left standing on the so dispensing with chocks. Models in production are for Cadet, 12' National, International, 14' G.P. Hornet, etc. The weight is approx:

## BOAT COVERS

Proofed Cotton Duck

Can be supplied to suit any boat. Covers are very well made with depth of skirting all round, eyeletted and cut to suit boat whether stepped or not. Drawings or Pattern of deck must be supplied for those than those listed in this booklet.

7 FT. 9 IN. ALL-PURPOSE LIGHT-WEIGHT YACHT'S DINGHY

Reprinted extract from "Yachting World"—Photos by courtesy "Yachting World"

- (ix) She should be easy and economical to build and the design should lend itself to the manufacture of sets of parts.
- (x) Appearance must be studied, because no one likes an ugly boat even if it is only the yacht's dinghy.
- (xi) Weight must be kept low for the dinghy to be lifted on board the small cruiser and for carrying up a causeway or beach.

At first sight this list of requirements did not look too difficult. We commissioned a design; but our task was not so easy as it looked. In all, five prototypes were built before we were satisfied that, balancing the above eleven points one against the other, we had arrived at about the best possible compromise. All prototypes were built by The Bell Woodworking Co., Leicester, whose advice on making the dinghy suitable for production in sets of parts was, of course, invaluable. The result is the Yachting World Utility Pram.

The illustrations show that she, like other Y.W. "Build Her Yourself" designs, is a hard-chine plywood skinned boat but, this time, with a difference. Instead of the usual flat box-like sides, it has been found possible to introduce a small amount of curvature in the plywood skin which increases forwards to a nicely rounded bow transom of considerable width.

In such a short boat, carrying capacity can only be obtained without undue depth, by going for a large beam and a plan of the biggest possible area. This means broad ends for, obviously, a rectangular punt would be the best weight carrier.

When carrying yacht's gear the centre thwart is often in the way. Y.W. Utility Pram has, therefore, three frames which facilitate building and allow the middle and after thwarts to be taken out altogether or used in alternative positions. Floorboards are raised above the level of the bottom of the boat to allow room for bilgewater and to keep gear and luggage dry.

The completed boat is light and only weighs 90lb. and will travel comfortably upon the roof of an 8 h.p. car.

As a sailing boat, handling qualities are good and performance is adequate for the purpose for which she is intended. It was difficult to get a big enough sail area because the mast and all spars must stow in the boat. A fairly big roach was, therefore, necessary but, if it is desired to dispense with sail battens, a straight leach must be used, and about 3 sq. ft. of sail sacrificed. Gunter rig gives, to all intents and purposes, a bermudan sail and there is little loss in efficiency. If the boat is not wanted to sail, the dagger plate case can be omitted and if necessary be put in later.

Under power, the "Utility" performs well. She is seen with a Seaquill Model 40 Plus; but any make of lightweight motor such as British Anzani Minor or Pilot, can, of course, be used.

There is no need for the outboard motor to be in the centre of the transom. Propellor torque more or less cancels out when fitted to one side, usually to port; but we are more inclined to fit the motor so that carburettor, choke, and petrol tap are accessible.

No buoyancy arrangements are shown because built-in buoyancy reduces cargo space; but air bags must be fitted before children are allowed to sail the boat.

The skeg helps the boat to run straight when being rowed or towed and the hand-hold can also be used to secure the boat when stowed bottom up on deck.

Provided Y.W. Utility Pram is built of the specified materials no difficulty will be found in her construction.

Like other Y.W. "Build Her Yourself" designs the "Utility Pram" is intended to be screwed and glued together. Mahogany plywood specification BSS 1088 to AX 100 glueing must be used for the skin otherwise

the proper curvature may be difficult to obtain. Frames and all other wood parts are African mahogany except gunwales and chines, which should be cypress and floorboards, which should be knot-free pine. Mast and spars are of sitka spruce.

PLANS — £1 2s. 6d.

A set of "Yachting World" plans are necessary for assembling parts. Price £1/2/6d. post free.

PREFABRICATED PARTS

To suit varying requirements we decided to offer these in three different Kits:—

- No. 1 for Pulling Version.
- No. 2 for Sailing Version.
- No. 3 for Converting pulling dinghy to sail if required at a later date.

Also to offer a choice of normal convex transom beams or concave, as illustrated. We strongly advise the latter if dinghy is to be stowed aboard.

No. 1 Pulling Version

Complete set of all timber parts, plywood, screws and glue:—

£16 15s. 0d. delivered

Deposit on returnable case £2/0/0d.

Frames and transoms are sent out completely assembled ready to set up on the packing case, one side of which is specially prepared for this purpose. Hoq, keel, chines and gunwales are cut dead to length and bevelled. This enables one to assemble framework within a few hours ready to fair off to receive the

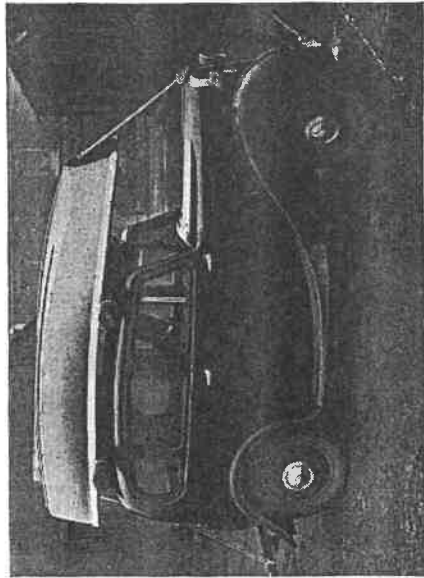

Easily carried on 8 h.p. Car

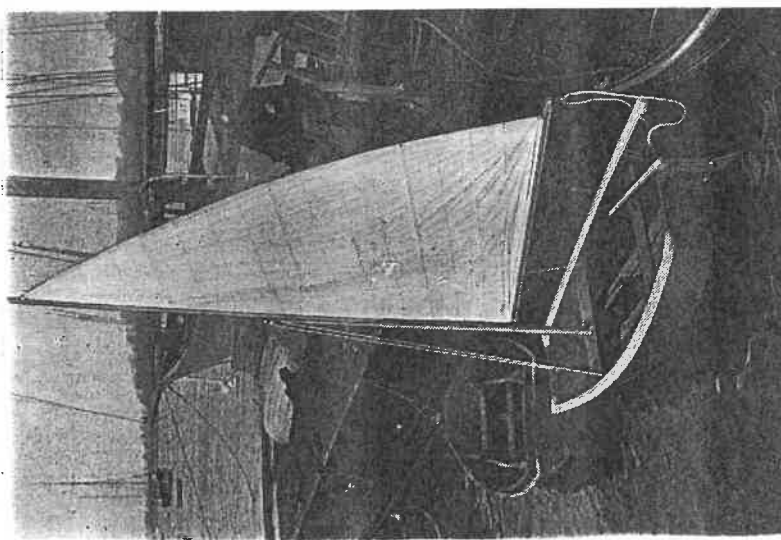

- A. .... 7ft. 9in. Sail Area: Large 33 sq. ft.
- n ..... 3ft. 11in.
- th of transom 15in. Weight, Rowing ... 90 lbs.
- ght 5" and 1' 10" " Sailing ... 112 lbs.

AFTER more than a year ago it became apparent to us that there was an unsatisfied need for a "Build Her Yourself" yacht's dinghy so we started to work upon what we then thought to be a fairly straightforward task.

The qualities needed should, we considered, include the following:—

- i) Since the trend is towards smaller cruising yachts, length should be limited to between 7ft. 6in. and 8ft.
- i) She must be safe and stable.
- i) The ideal dinghy should carry four adults with baggage with reasonable freeboard and without being unduly deep.
- ) The dinghy should have a reasonable performance under sail to save rowing or motoring and to provide recreation for children when the parent ship is in an anchorage.
- ) Spars and gear must stow inside the boat.
- ) She must tow well.
- ) The stern height must be suitable for any make of small outboard motor and performance under power must be satisfactory.
- ) The dinghy must be easy to row.



plywood. All remaining parts, except plywood panels, are prefabricated as far as possible ready to fix with little or no fitting. Plywood is Mahogany throughout and specially made for this dinghy to AX 100 test. All screws (approximately 5 gross) are brass and glue instructions are sent with glue.

Standard kit allows for Plywood Gunwale trim and Mahogany rubbing strakes, but if padded canvas fend-offs are wanted these can be supplied for an extra over cost of £2/0/0d.; the extra items being, two made-up canvas covers, 30ft. sorbo rubber strip, tube of Bostik and 7 dozen brass screws.

### No. 2 Sailing Version

All as No. 1, but with centreboard case and knees, centreboard and capping, rudder blade and cheeks, tiller, mast step, mast, gaff and boom. The latter two items are ready glued up.

£21 10s. 9d. delivered

Deposit on returnable case £2/0/0d.  
Extra over for fendoffs—£2/0/0d.

### No. 3 Conversion Kit

Centreboard case and knees, centreboard and capping, rudder blade and cheeks, tiller, mast step, mast, gaff and boom.

£5 5 0d. delivered

**SPECIFICATION:** Chines, gunwales, gunwale doublings, tiller, mast, gaff and boom—PRIME SITKA SPRUCE. Centreboard case and movable thwart—CLEAR RED CEDAR. Rudder blade, centreboard and transoms—MAHOGANY PLYWOOD to AX 100. All remaining parts—PRIME AFRICAN MAHOGANY.

### FITTINGS AND RIGGING

	£	s.	d.
A & B		9	0
C	1	1	0
D		6	0
E		5	6
F	2	6	
G	2	6	
H	3	0	
J	1	6	
K	3	6	
L	6	0	
M & N		19	3
*O & P		17	6
*Q		1	9
*R		5	0
*S		1	0
T U & V	12	0	
	1	2	0
	6	0	
	9	6	
<b>TOTAL for Sailing Version</b>	<b>£7</b>	<b>13</b>	<b>6</b>
" " " Rowing "	"	"	"
	<b>£1</b>	<b>4</b>	<b>3</b>

Carriage & Packing 7 6 extra if not sent with Kit.

\* Only items needed for Sailing Version.

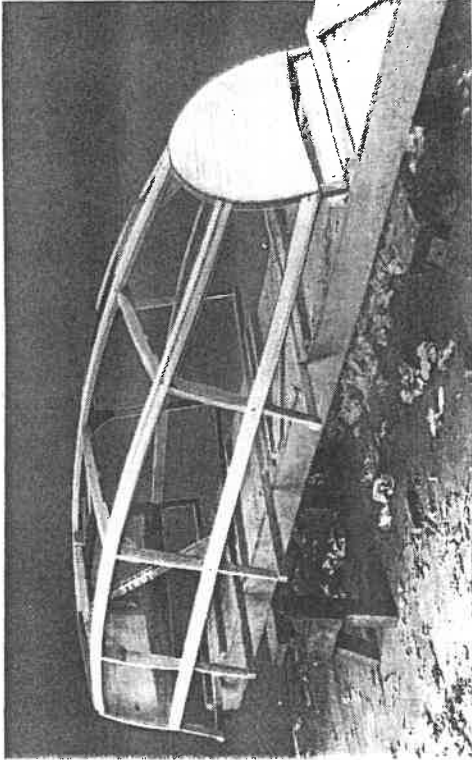

Frames set up on packing case

SAIL, extra with bag and battens ... £6 0 0

**TOTAL COST** of all foregoing items which are necessary to build complete dinghy:

(1) Rowing Version	£19	1	9
(2) Sailing Version	£36	6	0
Crate Deposit (extra)	£2	0	0
Padded Fend-offs if required	£2	0	0

### FINISHED DINGHIES

Pulling Version, Concave or Convex Transoms	£30	0	0
Pulling Version with fend-offs	£32	10	0
Sailing Version, Concave or Convex Transoms (ex sail)	£44	10	0
Sailing Version with fendoffs (ex sail)	£48	0	0

Prices ex works.  
All dinghies finished three coats varnish inside and out.

### TERMS

Strictly nett cash with order or against Pro-forma invoice.

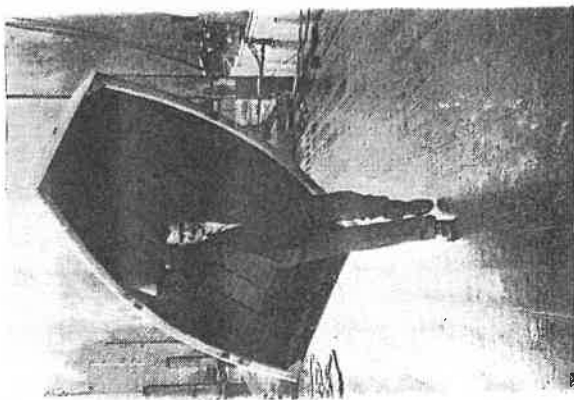
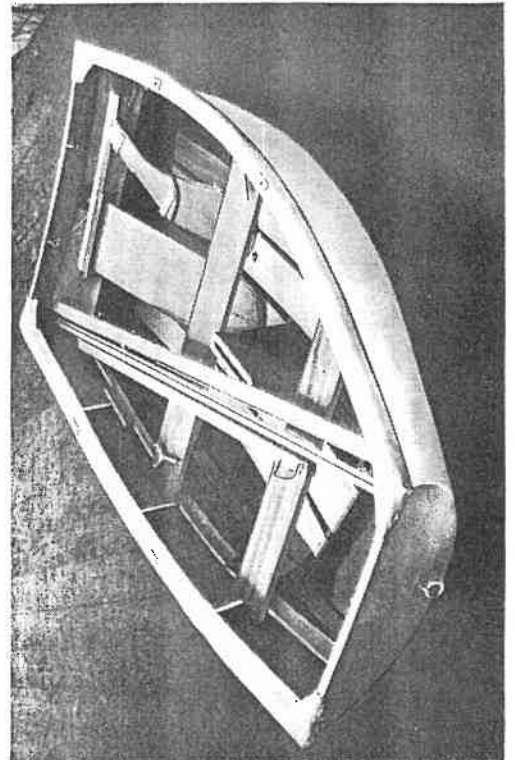

Pulling Dinghy weighs 90 lbs

### Extra items if required:

Canvas Boat Cover			
Galvanised Rowlock, pair			
6ft. Plain spruce oars, pair			
6ft. Varnished spruce oars, pair			
Seagull Model 40 Outboard Motor			
Seagull Model 40 Plus Outboard Motor			
Anzani Minor Outboard Motor			
Anzani Pilot Outboard Motor			
Buoyancy Bags (8lbs. P/B each), pair			
Rollers (Sorbo rubber canvas covered), carriage paid, per pair			

The last item is ideal for carrying dinghy on if fenders are not fitted to boat.

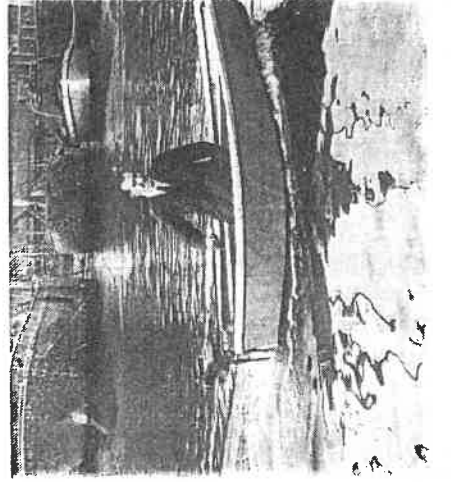

# ie "Yachting World" Cadet Sailing Dinghy designed by Jack Holt

THE "Yachting World" Cadet was designed by Jack Holt for Group Captain E. F. Haylock, who for many years studied the idea of an ideal junior class. It had to be cheap, and cost was reduced by making it easily built by amateurs in sets of parts. It had to be of good variance to instil pride of ownership. It is a class racing dinghy in miniature. The boat handles like a thoroughbred, is of high performance, and incorporates every possible safety precaution. Over 100 of these boats have already been built in twenty-six countries.

Dimensions: Length overall, 10ft. 6½in.;

Beam, 4ft. 1½in.;

Sail area: Mainsail, 42 sq. ft.;

Foresail, 13½ sq. ft.

Weight: Bare Hull, 120 lbs.

All up 150 lbs. approx.

Draught: 6½in. and 2ft. 6in.

Height of Mast above deck: 16ft. 0in.

## Kit of Every Wooden Part

Every wooden part necessary for the construction of the Dinghy is supplied in class timbers, planed, bevelled, sanded and bored for screws as far as possible, and conforming to the "Yachting World" Plans.

The frames can be assembled on the full-Plans as soon as the kit is unpacked. Completed frames are then set up on a floor ready to receive the hog, chines and gunwales. This method of construction meets the need for building stocks so that only a few hours' work is necessary to complete the framing ready to receive the planking. The method of marking out the floor is shown in full detail in sheet 3 of the "Yachting World" Plans.

Though the fore and aft transom knees are supplied loose for packing purposes

these have been fitted at our works to ensure exact relocation in the correct positions. The centreboard case is supplied ready made up as a unit. Mast is sawn down the centre and glued again for strength and rounded to correct taper. 3/16" Mahogany plywood panels manufactured to British Standards Specification 1088/1951 for the skin and decking are supplied sawn roughly to shape or marked out ready for cutting with ample allowances for fitting and butt jointing. Brass Screws, Copper Nails and Aerolite Glue and Hardener with instructions for use are supplied with every kit.

## SPECIFICATION

Frames, Transoms, Hog, Keel, C/Board Case,

Inwales, Washboards and Rudder Cheeks—

Prime African Mahogany.

Mast, Boom and Deck Beams—Prime Sitka Spruce.

Chines and Gunwales—Cypress or Sitka Spruce.

Floorboards—Pine.

Centre board—½" Mahogany Plywood.

Planking and Decking—3/8" Mahogany Plywood.

All plywood supplied is manufactured to British Standards Specification 1088 to AX100 Test in Mahogany throughout.

Our own Brief Building Instructions which supplement the "Yachting World" Plans for kit users are sent out with each kit. Assembly can commence as soon as the kit is unpacked.

Price £29/10/0

delivered within the United Kingdom.

A deposit of £1/10/0 is charged extra on the returnable packing crate timbers.

PLANS £1/5/0

A set of "Yachting World" plans are necessary for assembling parts. Price £1 5s. 0d. post free.

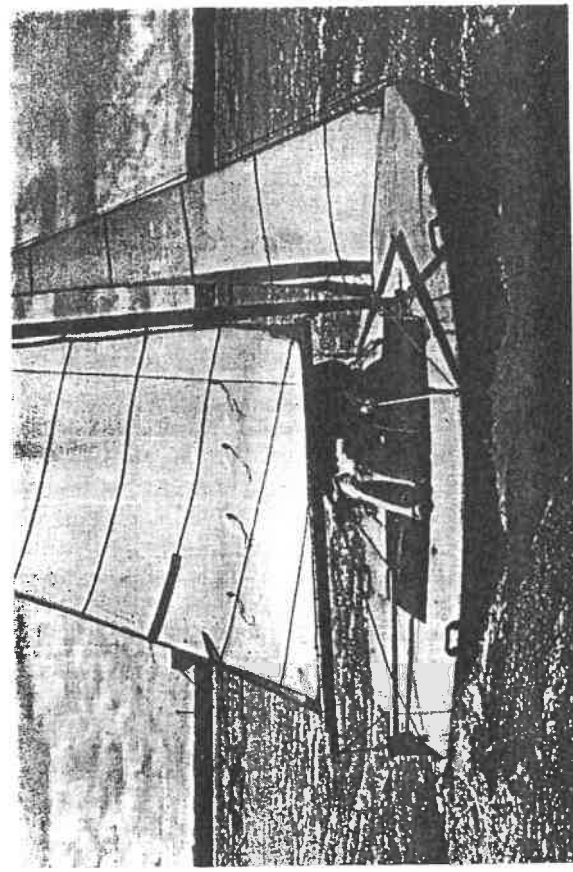
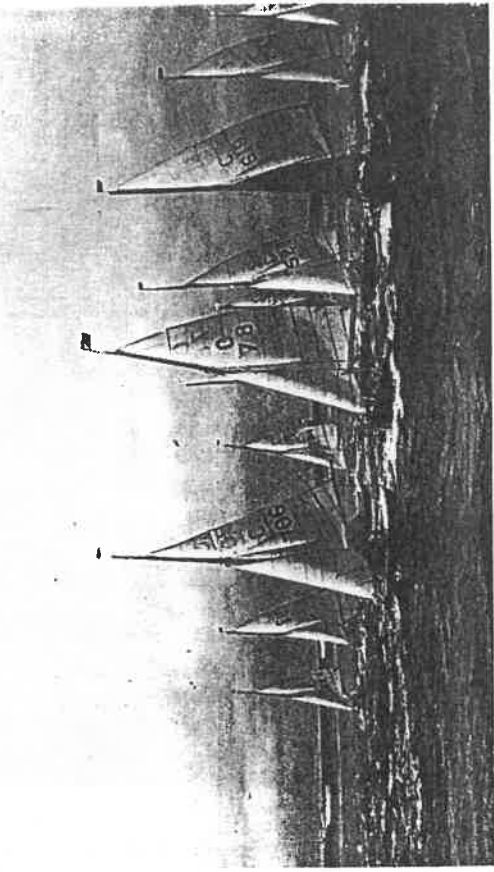

## SAILS

Mainsail and Jib complete with bag and battens with hanks fitted to jib and registered Y.W. Cadet Association numbers sewn on mainsail:—

Standard Quality ... .. 11 0 0  
Racing Quality ... .. 12 17 6

Spinnaker, complete with Boom and Lugs, Guys, Halyard, Block and Shackle:—

Standard Quality ... .. 4 5 0  
Racing Quality ... .. 4 15 0

Registered Y.W. Cadet Association numbers are sewn on to our stock suits, and we are able to register these in the name of owners, who need not therefore apply for numbers themselves.

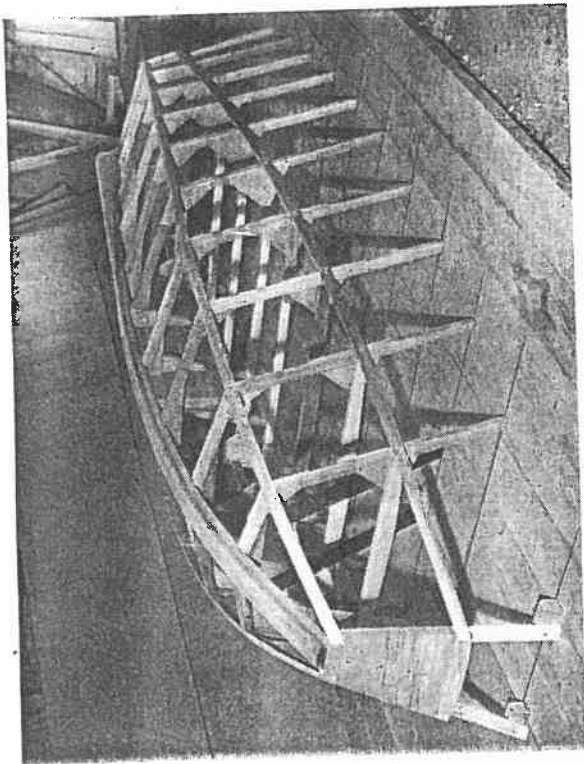

## ASSEMBLED HULLS

Completely assembled and fully decked hull as illustrated above, throughout with one coating of pink primer (or varnish according to the customer's wishes) together with mast, boom, dagger board wooden parts for rudder but no metal fittings. £42/10/0 e

Extra Items for the Cadet if required.

Set of four Deck Handles with brass fixing bolts, nuts and washers ... ..  
Kicking Strap, complete ... ..  
Pair of padded mast supports for carrying mast when trailing ... ..  
Additional Shackles, each ... ..  
Canvas Boat Cover specially made for the "Cadet" ... ..

## SPARES

Completely assembled rudder and tiller with extension varnished complete ready for use including blade and rudder fittings only —to suit our own transom fittings ... .. (delivered)  
Pair transom fittings to suit above rudder unit ... .. (extra)  
Centreboard and Cap assembled and varnished ready for use (delivered)

## PAINTS

Sufficient stopping, pink primer, paint, varnish and thinners to Cadet a first-class finish. The standard paint kit allows for the of the hull to be finished in Ivory Enamel, the exterior in the customer's own selected choice of colour, and the decks, main rudder stock, tiller, rubbing bands and splash boards in the Yacht Varnish. Alternatively, the insides may be varnished or finished in Ivory also.

Delivered price if painted inside and decks ... ..  
Delivered price if varnished inside and decks ... ..  
Delivered price if varnished throughout ... ..

## BUOYANCY BAGS.

Set of four specially made for Cadet £3/17/6

TOTAL COST of all foregoing items which are necessary to build the complete dinghy, £56/17/6 plus 30/- crate deposit. Including standard sails. Excluding spinnaker.

## COMPLETE DINGHY

£85/0/0 ex works

High standard of workmanship and finish guaranteed.

This price includes for Mainsail and Jib complete, full set of four Buoyancy Bags and all fittings and rigging specified in our own list. The price does not include the spinnaker and kicking strap fitting. The insides and decks are clear varnished but the outside hull is finished in Topside Enamel of the customers' own choice.

## TERMS.

Home.—Strictly nett cash with order or against

## FITTINGS AND RIGGING

Item	s.	d.
1 Forestay with lanyard, plate and shackle	12	6
2 Masthead sheave, pin and washers	2	3
3 Shroud and stay band in brass with screws	6	6
4 Brass gooseneck complete with screws	15	6
5 Boom tack fitting in brass with screws	4	9
6 Boom clew fitting in brass with screws and swivel	5	0
7 Pair of special Brass chain plates combined in fairleads for jibsheets	6	6
8 Pair of shrouds with lanyards and shackles	16	0
9 Jib halyard with shackle	7	3
10 Lightweight block for above with shackle	5	6
11 Main halyard with shackle	9	6
12 Cotton jibsheets and shackle	9	0
13 Cotton mainsheet with shackle and light plate	11	6
14 Lightweight block for above with shackle	5	6
15 Fairlead (transom fixing) for above	4	9
16 Top and Bottom Pintles and Gudgeons for rudder (Brass)	29	6
17 Pair brass flanged drain sockets and screws	3	0
18 Mast track with screws	16	6
19 Boom track with screws	7	6
20 Keelband drilled ready for fixing with screws supplied	21	0
21 Ringbolt (Galvanised)	1	9
22 Rudder Blade (Duralumin)	17	6

Complete set of all fittings and rigging shown above £11/5/0 delivered.

# "Yachting World"

## Heron (Cartop) Dinghy

THE SMALL TRANSPORTABLE BOAT WHICH NEEDS NO TRAILER

Reprinted extract from "Yachting World" April, 1951

EVERY demand for plans of the "Y.W." G.P.14 has left us no doubt that a hard chine plywood skinned boat, designed in amateur construction, fills a definite want. There are, however, "ould be" small boat constructors and sailors who live away sea and would like to take their boat with them when they alternatively, would like to take the boat on holidays to waters note. A 14-footer, however, needs a trailer, and this runs into expense, whether it be home-made or not.

apparent, therefore, that a boat which could be carried on an average small car of 10 h.p. and upwards, would save this expense. We therefore asked Mr. Jack Holt, who has produced a chine boats with superb sailing qualities, the "Yachting Cadet and the "Yachting World" G.P. 14, to design us a r ship to the latter which would still be capable of carrying a and two children without overloading, but which would be a trailer. The result is the "Y.W." Cartop dinghy.

a boat, 11ft. 3in. in length, in which constructional weight studied with the utmost care. She has only five frames, a entriplate and rudder, and is half-decked. She can be sailed, used with an outboard motor. Gunter rig has been adopted. ll spars, including the mast, can be stowed inside the boat. ototype proved to have all the excellent handling qualities of essors. She is light, and can easily be got on to a roof of a o people. The photographs show the prototype resting on lers. These are ideal, for the boat lashed on, as shown in graph, on a 150-mile journey showed no signs of moving

whose garages are high enough, the boat can be suspended oof, and hoisted a few inches clear of the car by means of

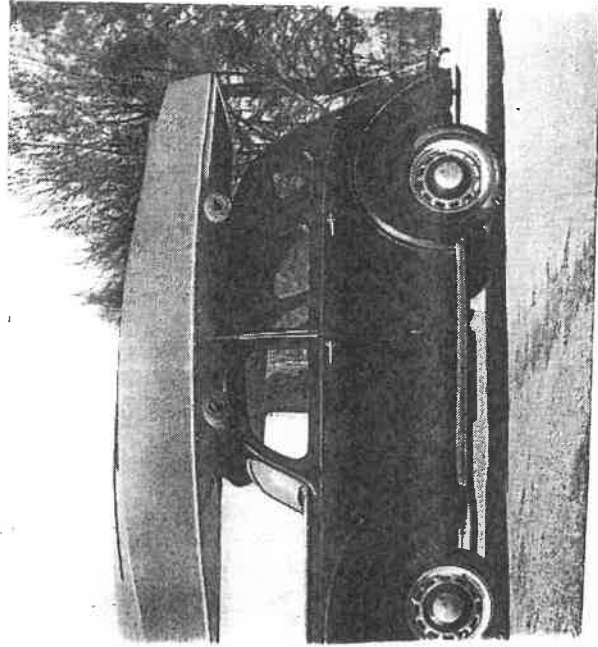

—Yachting World

owing to the small quantity of materials in her, her cost will be much lower than that of the latter. With an outboard she is a small motor launch; with neither power nor sail she can be used as a rowing boat.

### CLASS ASSOCIATION

Owners wishing to join the Class Association should contact the Secretary: L. F. Findlay, 18, Eastcote Road, Ruislip, Middlesex.

### Kit of Every Wooden Part.

Every wooden part necessary for the construction of the Dinghy is supplied fully machined in first-class timber, planed, bevelled and haunched as far as possible, and conforms to the drawings issued by the "Yachting World."

The transom and frames are assembled ready to set up on the floor and to receive the hog, chines and gunwales. This method of construction obviates the need for building stocks so that only a few hours work is necessary to complete the framing ready to receive the planking. The method of marking out the floor is shown in full detail in sheet No. 4 of the "Yachting World" plans.

Brief Building Instructions are sent with each Kit, and assembly can be started as soon as kit is unpacked.

Price £34/10/0, carriage paid inland or F.O.B. U.K. Ports.

Packing crate £2 extra. This amount will be refunded in full if crate timbers are returned carriage paid in good condition.

### SPECIFICATION:

Frames, Floorbearers, Keel, Hog, Transom, Apron, Carlins, King Plank, Side Deck and seat knees, Rubbing Beads and Rudder Stock—Mahogany.

Chines, Gunwales, Thwart Risers, Mast, Gaff and Boom—Sitka Spruce.

Note:—Gaff and boom are glued up ready for sanding.

Centreboard case, Thwarts and side seats—Prime Western Red Cedar.

Tiller, etc.—Ash. Floorboards—Pine

Skin—3/16" Mahogany plywood marked out in 12 panels together with 4 jointing strips.

Centreboard (fitted with Kautex pads and Rubber Stops) and Rudder Blade—3/8" Plywood.

All plywood is made to B.S.S. 1088 tested and stamped.

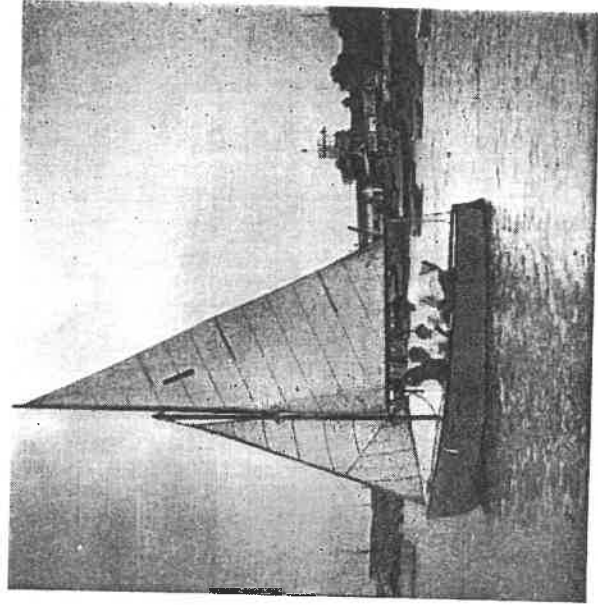

L.O.A. 11' 3" BEAM 4' 6" SAIL AREA 70 sq. ft.

Weight of Complete Hull 144 lbs.  
DRAFT (centreboard down) 3 ft.

two small tackles. For this purpose eyebolts to screw into the keel have been devised.

A lot of thought has been put into the design of this little boat, and only the minimum of parts have been used so as to ensure a light boat which, at the same time, can be easily constructed. On trial the "Y.W." Cartop dinghy, on account of her light weight, rowed easily, and with a Seagull Model 40 outboard motor her performance under power was satisfactory. When not in use the motor can be carried in the stern.

One of the chief difficulties encountered in designing a small sailing boat is to prevent people from sitting right in the stern, and for this reason the stern thwart is well forward with side benches, and when sailing the crew should sit as near amidships as possible. Rubbers have been fitted to the bottom to prevent the plywood from being damaged when the boat is carried up and down a beach, while the skeg ensures steady running.

The centreplate has no tackle and, like the G.P. 14, is wooden and held in position by a friction pad.

Intended as a small knockabout dinghy for family use, the "Cartop Dinghy" provides a step between the Cadet and the G.P. 14 as regards size and cost, although,



## FITTINGS AND RIGGING.

Item	£	s.	d.
1 Wire to rope Forestay .....	1	0	0
2 Pair of shrouds c/w shackles .....	1	2	0
3 Jib block spliced to bridle .....	6	6	6
4 Tufo! masthead sheave and pin .....	2	6	6
5 3 King Post sheaves and 2 pins .....	4	0	6
6 Bowplate (Tufo!) Jib tack eye and bolts .....	4	6	6
7 Forestay block, fixing plate and bolts .....	4	6	6
8 Pair chainplates c/w plates and bolts .....	3	6	6
9 Pair bullseye fairleads and bolts .....	10	0	0
10 Mast plate (Tufo!) c/w screws .....	1	9	9
11 Tiller Hood c/w pin and screws .....	3	9	9
12 Set of brass pintles & gudgeons for rudder .....	1	10	6
13 Pair Rowlock Plates (Tufo!) and screws .....	1	2	6
14 Pair of brass screw-in lifting eyebolts and plates .....	6	0	0
15 Brass Boom Tack fitting c/w pin .....	4	9	9
16 Brass Boom Clew fitting c/w swivel .....	5	0	0
17 Brass Sliding gooseneck and Gaff Band .....	1	1	0
18 Keelband in brass strips .....	1	1	0
19 1" Cotton Mainsheet c/w shackle .....	10	6	6
20 Mainsheet Blocks c/w shackles (2) and 2 plates .....	13	0	0
21 1" Cotton jibsheet with shackle .....	10	0	0
22 Main Halyard in 3/4" hemp with shackle .....	9	6	6
23 Jib Halyard in 3/4" hemp with shackle .....	9	0	0
24 3 Ash Cleats for halyards and forestay .....	3	9	9
25 5/16" Elastic and Anchor Plate for Rudder .....	4	0	0
26 5/16" Brass Bolt, Nut, Washers and Rubber Rings for Centreboard Pivot .....	2	6	6

Complete set of all above items £11/10/-.

Carriage Paid.

Individual items add 5% for packing and carriage.

## FASTENINGS.

Complete set of all fastenings, including brass screws, copper nails, Aerolite Glue and Hardener and Prestik Tape. £2/15/0.

PLANS — £2 10s. 0d.

A set of "Yachting World" plans are necessary for assembling parts. Price £2 10s. 0d. post free.

## SAILS

Mainsail and Jib with hanks fitted, sailbag and battens ..... 12 17 6

TOTAL COST of all foregoing items which are necessary to build the complete dinghy, £64/2/6 plus £2 crate deposit.

## OUTBOARDS.

Seagull Model 40 Outboard Motor ..... 25 0 0  
 Seagull Model 40 plus, Outboard Motor ..... 35 0 0  
 British Anzani "Pilot" Outboard Motor ..... 34 10 0

## COMPLETE DINGHIES

READY TO SAIL  
 High Standard of Workmanship and Finish Guaranteed.  
 £85 ex works. Sails extra

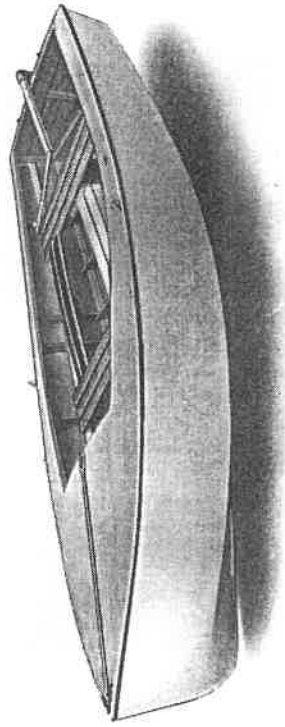

## PARTLY ASSEMBLED HULL.

Planked up Hull with Deck Beams fitted ready to receive King Plank, Decking, Centreboard and Case, Rubbing Beads, Floorboards and Thwarts, all of which are supplied together with Rudder Parts, Fastenings and Spars.

£49/5/0 ex works.

primed or varnished one coat on outside only.

Set of paint, varnish, primer and stopping to paint outside hull and varnish interior and decks £3/15/0 carriage paid.

## TERMS

Strictly Net, cash with order or against pro-forma invoice.

## EXTRA ITEMS, IF REQUIRED:

	£	s.	d.
Pair of Mahogany lifting handles .....	5	9	9
Rubber rollers for Car Top (see illustration) (ex-W.D. Surplus) .....	3	5	0
Rowlocks, galvanised iron .....	6	0	0
Kicking strap complete .....	12	6	6
Pair of 6' 6" Spruce Oars, varnished .....	2	6	6
Boat Cover .....	7	5	0
Provisional Plans with the complete dinghy .....	1	7	6

## CARTOP DINGHY for use with OUTBOARD MOTO



The Car-Top Dinghy can be built as an outboard run and can later be converted into the sailing version if required. The King Post is fitted also the Forestay block under the

For people who wish to build the boat this way with together a complete set of parts as follows:—

Prefabricated timber parts as for sailing version (less and case, spars and rudder parts) Keelband, Bowplate Block, Screw-in lifting eyebolts and plates and all necessary

£33/10/- carriage paid inland or F.O.B. U.K. F

Packing crate £1 extra. This amount will be refunded if timbers are returned carriage paid in good condition

COMPLETE DINGHY AS ILLUSTRATED ABOVE (excluding outboard motor)

£59/0/0 ex works.

## PARTLY ASSEMBLED HULL FOR OUTBOARD MOTOR

Planked up Hull with Deck Beams fitted ready to receive King Plank, Decking, Thwarts, Floorboards and Rubbing Beads are supplied with the necessary fastenings.

The "Yachting World"

# 14ft. G.P. Sailing Dinghy

designed by Jack Holt

**Comfortable - Roomy - Fast**

### Designed to meet the following needs:—

- High performance with a crew of two.
- Ability to carry at least four adults.
- Good stability.
- Good Seaboot suitable for estuary use as well as inland waters.
- Ample room for general purposes.
- Able to lie at moorings.
- Strong and able to take the ground.
- Simple rig with no expensive fittings.
- Suitable for rowing, or outboard motor.
- Easy construction for amateur building.
- Suitable for manufacturing as sets of parts.
- Light in weight for easy handling.

Extensive trials of the prototype proved the most successful and resulted in a really cheap boat for estuary and inland water sailing. Well over a hundred and fifty boats were built within one year of the design being published and as many Clubs have adopted the boat as their One Design and the formation of an Owners' Association became necessary.

Photograph by P. E. Tyler

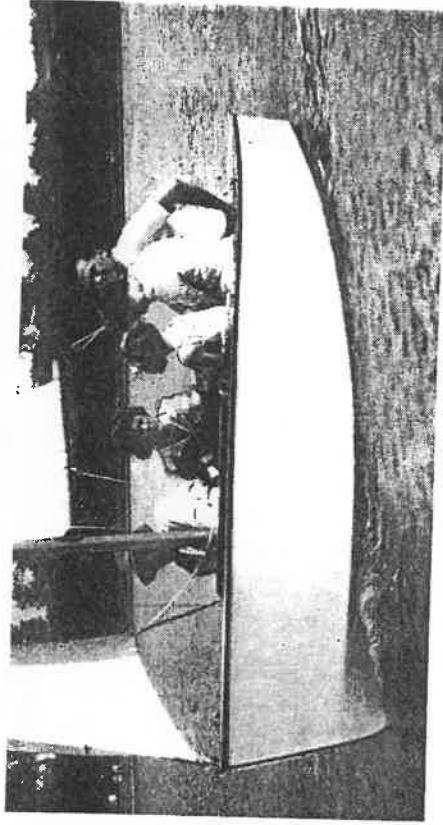

### Kit of Prefabricated Timber Parts.

Every wooden part necessary for the complete boat is supplied and as all parts are machined as far as practicable by us the amateur builder is able to build this dinghy with the ordinary hand tools of a "Handy-man's" kit.

The Stem, Transom and Frames are all assembled ready to set up on the floor and to receive the Hog, Chines, Gunwales and Stringers. The method of construction obviates the need for building stocks so that only a few hours' work is necessary to complete the framing ready to receive the planking. Brief building instructions and a plan for marking out the floor and erecting the frames are supplied with every kit.

Planking and decking of Mahogany Plywood as specified on plans is supplied in oversize panels to allow for cleaning off as no difficult fitting of rebates is called for in building this boat.

The centreboard case and cappings are sent out as a completely assembled unit ready for fitting. Mast, Boom and retractable Rudder are also supplied glued up ready for sanding.

**PRICE** (including designers' Royalty) — £55/10/-.  
Carriage Paid Inland or delivered to U.K. Ports.

A deposit of £2 is charged extra on the packing crate. This amount is refunded in full when the crate timbers are returned to our works carriage paid bearing the sender's name and relative invoice number.

Photograph by P. E. Tyler

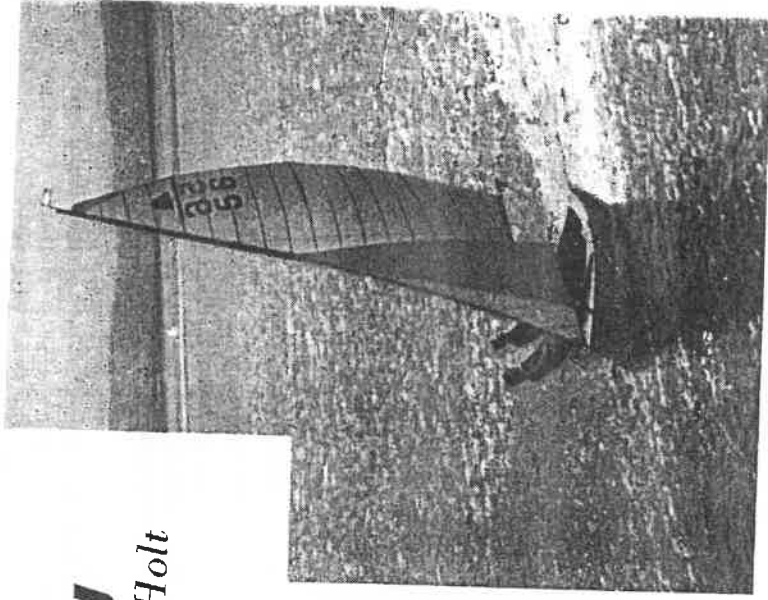

### DIMENSIONS

Overall Length	14' 0"
Waterline Length	13' 6"
Beam	5' 0"
Draft	7"
Draft with centreboard	3' 0"
Sail Area : Mainsail	72 sq. ft.
Jib	30 sq. ft.
Weight of complete Hull with floorboards	285 lbs.

### SPECIFICATION

Prime African Mahogany—  
Frames; Stem; Transom; Hog; Keel; Centreboard Case; Frame, Thwart and Hanging Knees; King Planks; Washboards; Rudder Stock Thwart; Side Benches; Coamings; Mast Step; Chine Fillets; and Rubbing Strakes.

Prime Sitka Spruce—  
Mast, Boom, Chines, Deck Beams, Mast Pad, Gunwales, Inwales and Stringers.

Clear Pine—  
Floorboards and Bearers.

Ash—  
Tiller and Halyard Cleats.

$\frac{1}{4}$ " B.S.S. 1088 Plywood or  $\frac{1}{8}$ " Mahogany for Centreboard.

$\frac{1}{4}$ " B.S.S. 1088 Plywood Rudder Blade.  
All Plywood is manufactured in Britain.

**PLANS — £2 10s. 0d.**

A set of "Yachting World" plans is necessary for assembling parts. Price £2 10s. 0d. post free.

**FASTENINGS :**

Complete set of all fastenings, including brass screws, copper nails, Aerolite Glue and Hardener, and Prestik Tape to complete the boat — £5/0/0 delivered.

**FITTINGS AND RIGGING**

- 1 1 pair Shrouds c/w Links and rigging screws 1 10 0
- 1a 1 Forestay c/w Links and rigging screws 15 0
- 1b 1 Main Halyard wire to rope with 1 shackle 16 6
- 1c 1 Jib Halyard wire to rope with 1 shackle 13 6
- 2 1" Cotton Jib and Mainsheets spliced c/w shackles 18 6
- 3 Pair of Laminated Plastic Sheet Blocks c/w shackle 18 0
- 4 Pair of light anchorage plates for transom fixing 1 9
- 5 Pair of masthead and butt sheaves for main halyard 4 6
- 6 Pair of masthead and butt sheaves for jib halyard 4 6
- 7 Shroud and Stay Band in brass with fixing screws 6 6
- 8 Gooseneck in gunmetal with fixing screws 16 6
- 9 Pair of boom end fittings in brass with fixing screws and cotter pin 16 6
- 10 Stem Head Fitting in gunmetal with shackle 14 0
- 11 Pair of lignum vitae Fairleads with tapped rod, nuts, washers and brass plate 12 0
- 12 Set of brass Rudder Fittings for retractable rudder with tiller Hood, Clip, Elastic Cord, Cleat and all fixing bolts, nuts and screws 1 19 6
- 13 Pair of Chainplates in brass with fixing bolts 6 0
- 14 Brass Bolt, nut, Washers and rubber rings for Centreboard Pivot 3 6
- 15 Pair of brass flanged Drain Sockets with screws 3 0
- 16 Mast Gate in brass with screws 6 6
- 17 Rubber Buffers with bolt and nut for centre board handle 1 6
- 18 18' 6" x 3/4" feather edge brass strip for Keel-band with two junctions for centreboard slot and screws 2 10 0

Complete set of all above fittings and rigging Carriage Paid ... .. £15 0 0

For individual items add 5% for carriage and packing.

**TOTAL COST** of all foregoing items which are necessary to build the complete dinghy **£78**, plus crate deposit £2.

**SAILS**

Mainsail and Jib complete, with hanks fitted, battens and sail bag in Standard materials ... .. 14  
 Mainsail and Jib complete, with hanks fitted, battens and sail bag in Best Quality materials ... .. 18  
 Owners' Association Numbers and Insignias can be sewn on Mainsail for £1 extra.

Spinnaker complete in standard material ... .. 6  
 Spinnaker complete in best quality material ... .. 8

Owners wishing to join the Y.W. 14ft. G.P. Owners' Association should contact the Secretary: D. W. Pollock, The Cottage, Countesthorpe, Leicestershire.

Paint, Varnish, Primer and Stopper for painting outside and varnishing remainder £3/15/0 carriage paid.

**EXTRA ITEMS IF REQUIRED**

- Kicking Strap, complete with boom fitting ... .. 1
- Buoyancy Bags: Size 1—4' 6" x 10' inflated diam. each 150 lbs. positive buoyancy, pr. 4 1
- Size 2—3' 0" x 9" inflated diam. 80 lbs. positive buoyancy, each 1
- Pair of padded Mast Supports for carrying mast above boat when trailing ... .. 1
- Canvas Boat Cover, specially made ... .. 9
- Pair of Galvanised Rowlocks with brass sockets ... 2
- Pair of Spruce Oars ... .. 2
- Pair of Lifting Handles ... .. 3
- Chromium Plated Bilge Pump ... .. 3
- Paddle ... .. 1

**OUTBOARD MOTORS suitable for the G.P.**

- British Anzani "Pilot" 1 1/2 h.p. ... .. 34
- British Seagull Model 40 Plus ... .. 35

**SPARES**

Centreboard, complete with Friction device, varnished for use £2/15/0, carriage 5/- extra.  
 Rudder blade varnished 17/6, carriage 2/6 extra.

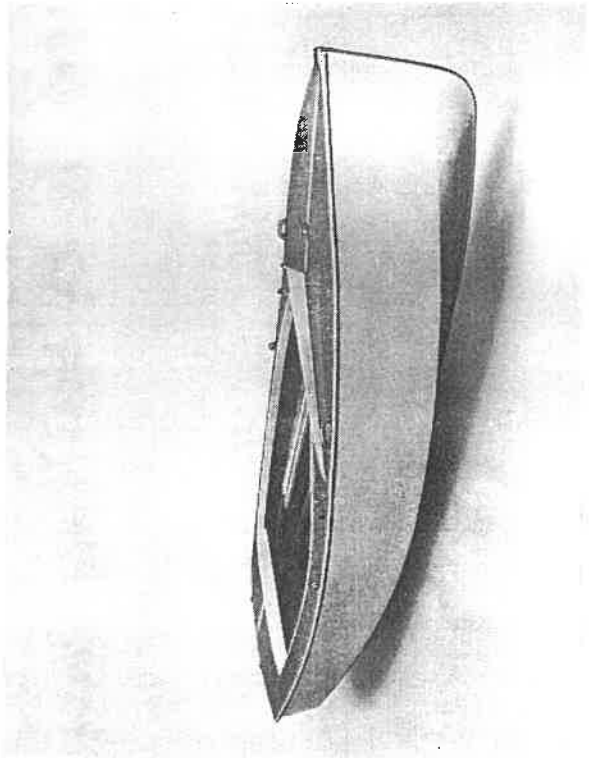

**COMPLETE DINGHY READY TO SAIL**

High Standard of Workmanship and Finish guaranteed.  
 £118 ex works. Sails extra.

**PARTLY ASSEMBLED HULLS**

Primed one coat outside and varnished one coat inside. Deckbeams fitted only. Centreboard and case, Deck Panels, Washboards, Coamings, Rubbing Strakes, Rudder Parts, Floorboards and Bearers. Mast and Boom are also supplied for completing boat.

£77 10s. 0d. ex works

**TERMS**

Home.—Strictly nett cash with order or against Pro-Forma Invoice.

# The "Yachting World" 16 ft. Hornet designed by Jack Holt

Re-printed extract from "Yachting World"—Photos by courtesy Yachting World

with no other class but which will, at the same time, have a performance not exceeded by any existing class boat at any cost.

The 16ft. Hornet is a hard chine plywood boat with a comparatively small sail area but, owing to her light weight and her length, she is capable of very high speeds and will plane with the wind forward of the beam. In spite of her size she will, however, not be unduly expensive to build because, as the result of experience, we have been able to simplify her construction.

Nothing stops a boat like too much beam, and owing to her small sail area and to the additional stability conferred by her length the Hornet's beam is only 4ft. 7in., which is less in proportion than that of the average racing dinghy. The 224lb. hull is very easily driven and 120 sq. ft. of sail is all that is required. Some people will hold their hands up in horror to discover that a sliding seat has been provided for the crew; but once the comfort of the sliding seat instead of the normal back-breaking process of "sitting-out" has been experienced the crew will be quickly converted. The sliding seat when not in use will almost house within the beam and presents no inconvenience. With his crew on the seat the helmsman is largely relieved from the stress of sitting-out and can devote himself the better to sailing the boat.

#### DIMENSIONS.

L.O.A. 16ft. 0in. Mainsail 85.5 sq. ft.  
Beam 4ft. 7in. Foresail 35.5 sq. ft.

The centreplate, like all modern dinghies, is wooden and works without a tackle, while either a lifting or a drop rudder may be used.

Because of her size the Hornet is not sensitive to variations in the weight of the crew. In fact, the addition of a third member to the crew would make little appreciable difference to performance.

As the photograph shows, we have proceeded with this design with our usual care and built and tried out a prototype which has already been seen and sailed by a number of prominent dinghy helmsmen. The first impression on getting into the boat is of size. Compared with other racing dinghies she is a big boat. As soon as her sheets are hardened she is travelling fast within a few yards. She is surprisingly stiff and the experienced helmsman quickly discovers that she is unusually easy to handle. In a fresh breeze, except when on the wind, one seems to plane all the time. This is the sort of boat that

dinghy enthusiasts have always wanted. She has, in fact, an astonishing performance.

In adopting a comparatively large hull in order to get the requisite performance we were mainly concerned over the cost. But, as the result of experience, it has been possible to simplify construction and for all her 16ft. the Hornet will not be an expensive boat to build.

Normally designed as a plywood boat the Hornet may be built of any other material, light alloy or fibreglass provided she is not below the minimum weight, but

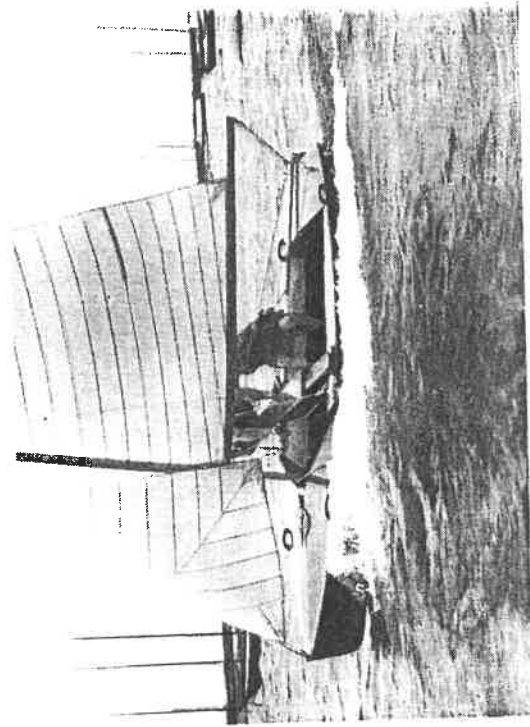

we do not intend to publish designs for anything other than plywood. Rigging is simple. The mast is hollow and goes right down to the keel.

Weighing no more than the average 14-footer the Hornet will be no more difficult to trail and there is no new problem in that direction.

In starting a new class it is essential that the class organization should be established and we have therefore formed a Y.W. Hornet Class Association which will deal with all problems connected with the class. The Secretary is Mr. D. R. Kenny, 19, Farringdon Street, London, E.C. 4, to whom all correspondence in connection with the class should be addressed. Rules have been drawn up and may be had on application to the secretary (price 2s. 6d. post free), who will issue measurement forms and class certificates.

ERIENCE with our "Build Her Yourself" series boats which began with the Cadet and included W. Day Boat, G.P.14 and Y.W. Cartop dinghies is that there are many people in Britain to-day to get on to the water but who are debarred by the high cost of boats. The "Build Her Yourself" idea is a considerable saving in costs besides giving to those who are good with their hands. There is an added thrill in building one's boat and in her.

was quite obvious that a 16ft. "Build Her elf" racing boat was needed and we, therefore, pressed the matter with Mr. Jack Holt who has prepared a design for a boat which will, we feel, conflict



**PLANS — £3 3s. 0d.**

A set of "Yachting World" plans is necessary for assembling parts. Price £3 3s. 0d. post free.

Designer's Royalty (to be paid to class secretary) **£2/0/0**

**KIT OF PREFABRICATED TIMBER PARTS.**

Every wooden part necessary for the complete boat is supplied planed, bevelled, haunched, tenoned or profiled as far as possible.

The Hog is complete with changing bevels, slotted for centreboard case, diminished as per plans and cut dead to length with correct end bevels. Changing bevels and rebate are machined in the Chines. The mast is glued up ready for final shaping and sanding with pull-throughs ready for attaching internal halyards. Boom is also glued up.

**SPECIFICATION.**

All timbers are supplied in Prime African Mahogany excepting the spars which are in Prime Sitka Spruce and the tiller and extension in Ash. All plywood is manufactured in Mahogany throughout to British Standards Specification 1088 of 1951.

**Price £59/10/0 Carriage Paid inland.**

A deposit of £5 is required to cover the returnable packing crate and the loan of the temporary building frames and the legs for transom. This amount will be refunded in full if crate and frames are returned to us in good condition within eight weeks.

Building instructions and a separate plan showing the set up of the frames are supplied with every kit.

The standard Kit includes for a Mahogany fixed rudder blade only. For a lifting rudder add 19/- for the extra over cost of an aluminium blade.

**FASTENINGS.**

Complete set of all fastenings including brass screws, copper nails, Aerolit Glue, Hardener and brass bolts to complete. **£5/5/0 delivered.**

**FITTINGS AND RIGGING.**

Plan. Ref. No.	£	s.	d.
4 & 15		2	6
5 & 16		2	6
16		2	6
1		12	6
2, 3 & 13		10	6
6		3	0
7		16	0
8		16	6
9		3	0
10		5	0
11		4	6
12		5	6
14		1	1
17, 18, 19 & 20		1	0
19, 20, 22 & 23		29	6
21		8	0
24		3	0
25		6	0
26		4	6
22		12	0
		2	5
		6	
		15	9
		1	11
		17	6
		15	0
		10	6
		1	4
		10	0
		5	0
		7	6

Complete set of all above items £17/10/0 delivered. Individual items add 5% for carriage and packing.

**TOTAL COST of foregoing £85 8s. 0d.**  
Crate and frames £5 extra.

	£	s.	d.
Mainsail and Jib, complete with numerals and insignia, hanks fitted to foresail, sail bag and battens. Standard finish. ....	16	15	0
Mainsail and Jib as above, best quality racing finish	21	12	6
Spinnaker sail c/w boom, guys, sheave and halyard	9	0	0
Spinnaker complete as above in best material .....	10	10	0

**SAILS**

**EXTRA ITEMS IF REQUIRED**

Buoyancy Bags:—

- Size 1. 4' 6" x 10" inflated diam., each 150 lbs. positive buoyancy, pair
- Shaped Bow Bag, 300 lbs. .... each
- Pair of padded mast supports for carrying mast when trailing .....
- Canvas Boat Cover, specially made .....
- Kit for Self-Draining Cockpit as specified in plans if required .....

**COMPLETE BOATS AND BARE HULLS**

We can supply HORNETS complete ready for decked as shown on plans at

**£150/0/0** ex works (sails extra)  
or

Assembled Hulls with the two main deck beams on and remaining timber parts sent loose for

**£85 0 0** ex works

**Terms:** Strictly nett cash with order or against Pro Invoice.

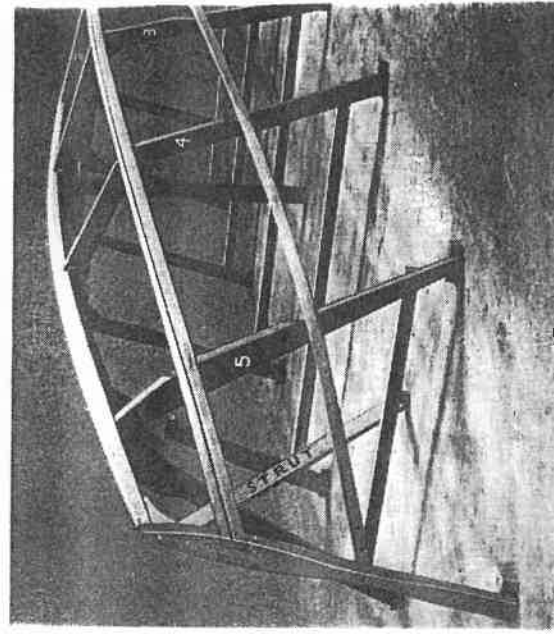

Temporary building frames set up.

# All Anglers' Dinghy

specialising in the manufacture of prefabricated sets of parts and Motor Boats for Home assembly we received from time to time requests for a Simple Anglers' Dinghy. During the year we received so many requests we decided to see what we could do about it and asked many Anglers a lot of questions and out exactly what was wanted and the following list of comments resulted:—

- Must be big enough for two or three people.
- Light enough for easy loading on to any saloon car roof and for easy carrying by two people.
- Easy assembly, capable of being built in one week-end.
- Strong enough to last a lifetime, no hinged or folding parts.
- Must incorporate at least one built in, self draining tank for live bait.
- Sufficient freeboard for choppy water.
- Maximum stability for casting in safety.
- Good rowing qualities.
- Suitable for propulsion by the cheapest reliable motor of British make.
- A short foredeck for dry stowage.
- Arrangements for hoisting to garage rafters for stowage.
- Cost to be about £20.

Drawings were made and three prototypes built before we compromise to incorporate all the required features was decided.

The final boat filled the bill in every way, weighing 102 lbs. is room and buoyancy for 3 people and you can take where at anytime if you have a saloon car of 6 h.p. or more, borrowed the smallest 8 horse saloon we could find to test this (illustration).

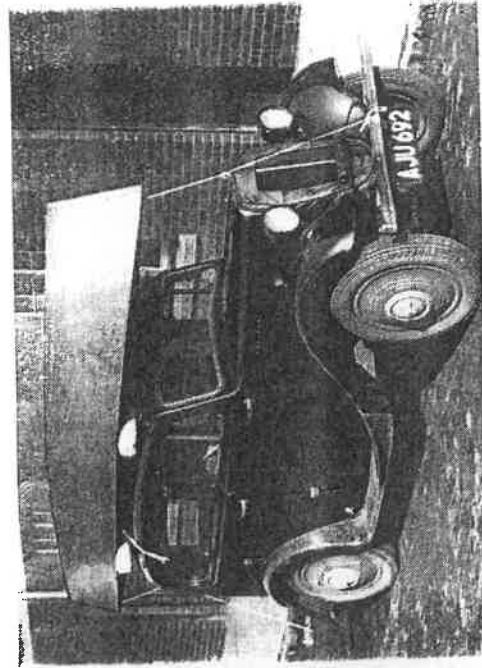

Using the same method as employed in connection with the 1.1 type of domestic clothes airing rack, it can be hoisted off roof and suspended from garage rafters for storage and lowered to roof when wanted in a very few minutes.



For easy carrying the seat risers run the whole length of the boat forming a hand hold at any point required to get a perfect balance, motor, boat and gear can be carried a long way without undue fatigue.

Two separate self draining tanks are built in, one for live bait and the other as a keep tank, filled to the required depth with a baler they are drained before finally pulling the boat out by removing the cork bungs in the transom.



3 h.p. Anzani Minor gives ample power for normal purposes.

Provision has been made for nesting the motor between the tanks for two reasons: 1, to obviate the necessity of standing right aft to fix the motor; 2, to afford maximum protection against bumping the motor against quay headings, etc.

It is a delightful dinghy to row the shallow skeg being sufficient to prevent yawing and the boat can be sent along at a good pace with little effort owing to its light weight and shallow draught.

The slightly rockered flat bottom chosen for this dinghy together with the general hull shape gives maximum stability, the floor boards are as low in the boat as possible consistent with a dry floor.

Your trust in this dinghy will soon grow to a surprising degree. It is safe to use anywhere except in a choppy sea.



Boat fishing doubles the pleasure and efficiency of the Angler and usually results in bigger and better catches.

With a boat you can fish under those overhanging hedges or right up to that promising patch of weeds with the sure knowledge that when you have your fish hooked you can lead him away to clear water in which to play him right into the net instead of through obstructions to the bank where so many fish are lost.

You can spin over all the available water with easy medium casts instead of spending half your time undoing "birds nests" caused by trying to cast too far out when bank spinning.

Also it is a much cleaner way of fishing, no slipping and sliding about near water's edge in heavy waders. Ordinary foot wear and a comfortable seat instead: in a boat everything is where you want it, that gaff you never expected to need to-day in bounce to be within easy reach instead of somewhere in the grass or several yards away up the bank, left with your lunch.

Now the last item No. 12, the price; we could not quite manage this unless we used second grade material but by making jigs for all the parts we brought the price down to

**£23 5s. 0d. delivered**

Price includes everything necessary to complete the dinghy except oars or outboard motor.

All copper nails, brass screws, glue and marine varnish included.

Frames are sent out assembled ready to set up in position on the special packing case (see illustration overleaf). These are bevelled and haunched ready to receive the hog, chines and gun wales; these too are sent out ready to fit so that the whole of the framework can be assembled by drilling a few holes, glueing an screwing.

Simple illustrated step by step instructions showing set up frames are sent out with each kit. These enable any practical type of person to assemble the complete boat in an average time of 15 to 20 hours, excluding varnishing. Varnish is easy to apply instructions for brushing this on are also sent.

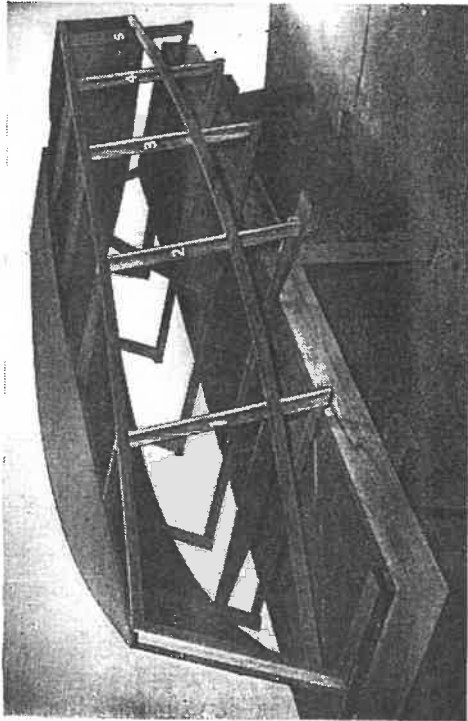

### FINISHED BOATS READY FOR USE

Standard dinghy, weight 102 lbs., varnished 3 coats ...	£33 0 0
Planked in 4" plywood for occasional hire work ...	£35 0 0
Planked in 5/8" plywood for regular hire work ...	£38 0 0

Prices are ex works, delivery can be made by passenger train or road transport. Carriage can be quoted for when destination is known. All boats are insured during transport.

Prices do not include oars and rowlocks, these can be supplied as follows:—

Plain, unvarnished ...	2	6	per pair
" varnished 3 coats ...	5	6	" "
Galvanised Rowlocks with plates	7	6	" "

### SPECIFICATION

With the following exceptions all timber is Prime knot free African mahogany. Chines and gunwales, Prime Kauri pine. Floorboards, Knot free whitewood.

Planking, 3/16" mahogany plywood specially made to the highest Marine specification known as B.S.S. 1088/51. Plywood is now the rule rather than the exception for planking small craft, in fact sea going craft are being planked nowadays with this material. Equal in strength to nearly double its thickness in mahogany it is easy to fix, results in a permanently dry boat and will not delaminate under any climatic conditions. Actually it is tested to withstand several hours in boiling water without delamination. Plywood panels are sent out full length ready to glue, and screw into place, a small allowance being given for fitting.

The Prefabricated kit of parts is sent out in a special case, this is used for actually building the boat on as shewn in top left hand illustration.

A deposit of £2/2/6 must be sent with order, for the case, this amount will be returned in full if case is returned to us within three weeks, alternatively we will send a pair of plain oars.

### TERMS

Strictly nett, cash with order or against pro forma invoice.

### OUTBOARD MOTORS

To conform to item 9 the dinghy was specially des the British Anzani 3/4 h.p. Minor, this motor gives a required for still or slack water. The dinghy is how for other motors of 1 1/2 h.p. and it may be advisable t of this power if dinghy is going to be used in w at 3 to 4 knots.

### PRICES

3/4 h.p. British Anzani Minor .....	1 1/2
1 1/2 " " " Pilot .....	40
Model 40 " British Seagull (A) .....	40 plus "
" 40 plus " " (B) .....	A—Approx 1 li.p. B—Approx 1 1/2 h.p.

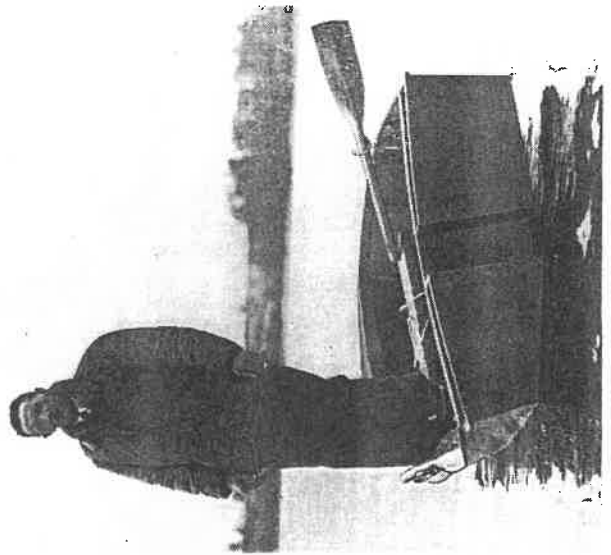
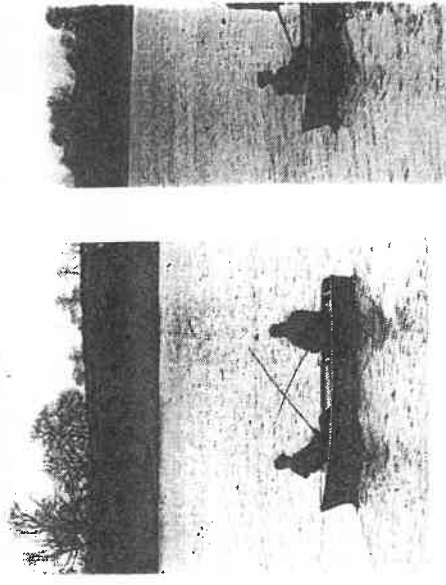

Maximum Stability for Maximum Safety.



Trolling — Motor steering stiffened in a few seconds to suit requirements.

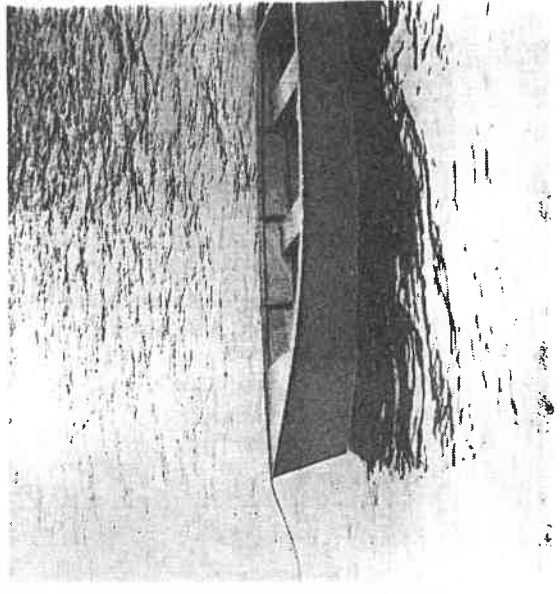

Length 10' 3" Beam 4' 2" Weight 102 lbs.

# 13 ft. Outboard Runabout

Reprinted Extract from *Yachting World*

**O**UTBOARD motors, in the past, have been called some hard names and some, though not all, may have deserved the epithets hurled at them. "Give a dog a bad name" [!] It is strange how many people continue to scoff at the outboard motor. To-day it is no longer a troublesome piece of ironmongery, but a very efficient, economical and reliable machine. The old bugbear of difficult starting is a thing of the past and, if the motor does not fire, hot or cold, on the second or third pull of the cord, then there is a good reason for it—nearly always, something the operator has forgotten to do such as turn on the petrol or open the tank air vent.

From the point of view of the amateur builder the outboard has many attractions, particularly in saving initial cost. The installation problem is reduced to either clamping on or screwing on a bracket. There is no shaft log to bore, no aligning of the motor, no petrol tank to install and no other fittings or piping. There is a great saving in weight, while the outboard takes up no room in the boat. It can be removed when not in use and kept in a dry shed under ideal conditions. Lastly, the outboard is cheap to buy and economical to run.

Although both the Y.W. G.P. Fourteen and the

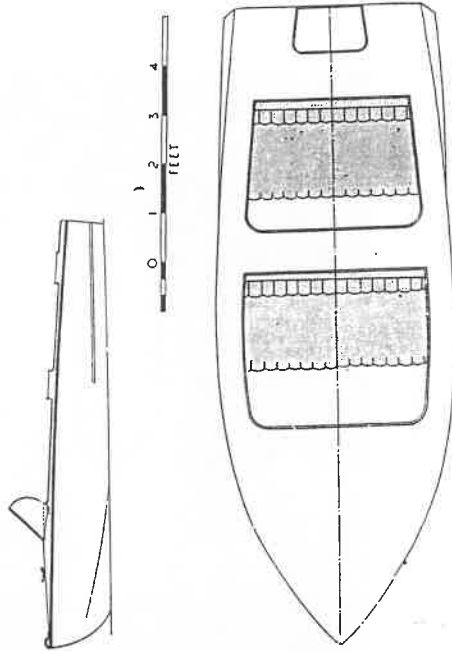

- Length ..... 13' 2" overall
- Beam ..... 4' 10" amidship
- Depth ..... 2' 4"
- Weight ..... 275lbs. without motor
- Seating ..... Capacity 4 persons

DESIGNED BY  
D. W. POLLOCK

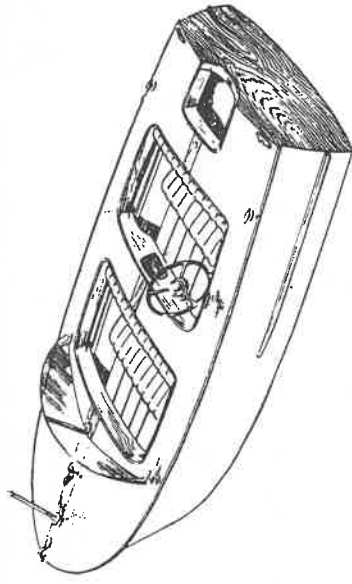

boats with or without their masts and sails, we consider that there is a demand for a motor launch. We therefore asked Mr. D. W. Pollock to work out a design for a safe, smart-looking Build Her Yourself plywood skin outboard runabout which would be easy on the eye as well as easy to build.

Two prototypes were built and tested to take any outboard engine made in Great Britain. The type recommended is one rated at about 4 h.p. of which there are several made in this country such as the Seagull 102; British Anzani 4 h.p. Super Single; Britannia Mariner; Ferrer; as well as a number of imported motors. Rock-bottom motor boating in sheltered waters can be achieved with a small engine like the latest Seagull model 40 plus. The transom is so arranged that it can be cut to the correct height recommended for any motor.

Particular attention has been paid to making the boat easy to build. The stem design developed on the Cartop dinghy is practically foolproof. There is a solid definite set-up arrangement for building which cuts out the need for building stocks, thus saving time, cost and material.

There is no riveting over washers or roves and the boat is screwed and glued together making a strong, leakproof hull which can be built by any amateur carpenter with only a small knowledge of boats.

Like other Y.W. "Build Her Yourself" boats, the Runabout is plywood planked because we have found it a completely satisfactory form of construction and one ideally suited to amateur building. Weight of complete hull is 267lb.

The design has been carefully planned so that it lends itself to the manufacture of prefabricated sets of parts. These have, in the past, been found to be a great convenience to inexperienced builders and dare we whisper it, to professional boatbuilders as well. From the prices charged for other boats we estimate that a complete set of timber parts, including the plywood skin, should work out at about £40. The timber for the builder who prefers to begin from scratch would cost only a little less at normal prices. This is because he has to allow for waste and he is seldom in a position to buy to such advantage as the professional maker of sets of parts.

Y.W. 13ft. Runabout, as the photographs show, is a good weight carrier and is stable and safe. The steering wheel can be placed in either cockpit or, if desired, direct steering by the usual method of swinging the motor can be used. The seats can be upholstered or, alternatively, plywood seats can be used which will carry the upholstery should it be desirable to add it afterwards. As there are no means of rowing the

runabout, one or two paddles should be carried for manœuvring at close quarters or in very shallow water.

Here is a boat which is the result of many years of experience with successful "Build Her Yourself" designs beginning with the Y.W. Cadet in 1947 and followed by the Dayboat, a round bilge 14-footer; the General Purpose 14; the Cartop dinghy; People's Boat; a hard chine cruiser. Now the easily built Y.W. 13ft. outboard Runabout is a unique combination of good appearance, stability and safety, good performance, economy and, above all, she is easy to build.

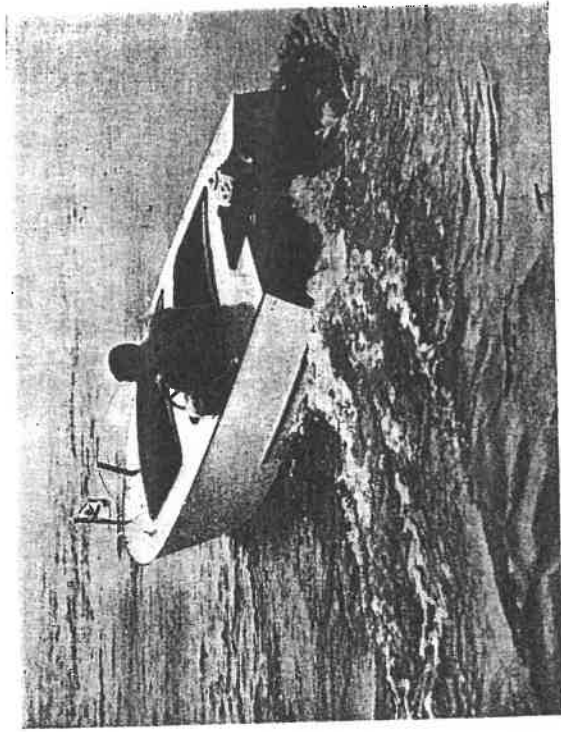

Right angle turns with safety.



**PLANS — £1 15s. 0d.**

A set of "Yachting World" plans is necessary for assembling parts. Price £1 15s. 0d. post free.

**PREFABRICATED KIT OF TIMBER PARTS**

Every wooden part and plywood necessary for the construction of the Runabout is supplied fully machined in first-class Mahogany and Sitka Spruce, bevelled and haunched as far as practicable to conform with the "Yachting World" plans.

The transom and frames are assembled ready to set up on the floor, these like the Inner stem are machined ready to receive (after slight fairing in) the hog, chines, gunwales and stringers. This method of construction obviates the need for building stocks so that only a few hours' work is necessary to complete the framing ready to receive the planking. Method of marking out floor and setting of frames is fully described in plans.

All necessary instructions are sent out with each kit and assembly can be started as soon as kit is unpacked, designers Royalty is included in the price of

**£49/0/0**

Carriage Paid Inland or F.O.B. U.K. Ports

A deposit of £2 is required on packing crates, this amount is refunded in full when the crate timbers are returned to our works, carriage paid, bearing the sender's name and relative Invoice number.

**SPECIFICATION**

Frames, Hog, Inner Stem, Knees, Breasthook. King planks, Seat framing, Coamings and all rubbers—Prime African Mahogany.

Chines, Gunwales, Stringers, Deck Beams, Carlines and Outer Stem—Prime Sitka Spruce.

Floorboards—Knot free pine or 1/8" Plywood.

Plywood is specially made in Sapele Mahogany throughout to AX100 Test requirements of BSSI088 and supplied in panels roughly sawn to shape, allowance being made for fitting. Bottom panels 1/4", Side vanels 1/4", Deck panels 1/4".

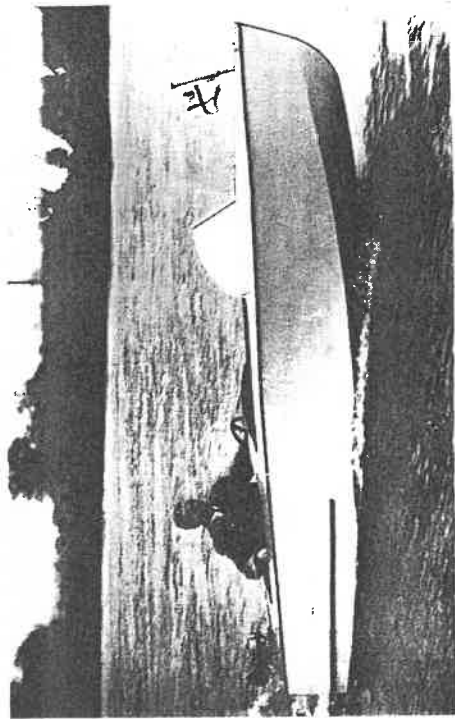

Good performance with 4 h.p. motor.

**FASTENINGS**

8 gross of brass screws; 1 1/2 lb. of copper nails as specified in Plans, together with glue and hardener to assemble kit.—£5/15/0d.

**FITTINGS**

	£	s.	d.
14' 6" 1/2 x 3/4" Half round Brass Keel and Stem band .....	1	2	6
Brass Sternhead fitting .....		7	0
* 4" Brass Cleat for fore deck .....		5	0
* 3" Port and Starboard fairleads, brass, pair .....		7	0
* 3" Brass Cleats for aft quarters, pair .....		7	0
* Perspex Windshields, with Chromed fittings .....	3	10	6
* Wheel steering c/w cables, sheaves & shackles .....	7	10	0

\* These items are optional.

All fittings are complete with fixing screws.

**MARINE PAINTS**

Topside enamel, one quart .....	}	£4 0 0
Undercoating, one quart .....		
Pink Primer, one quart .....		
Yacht Varnish, 3 pints .....		
Thinners for above, one quart .....		
White stopper, one lb. ....		carriage paid

Above quantities recommended for this boat.

Shade Card will be sent on request

**BARE HULLS**

Assembled bare hulls are available, these are sent out with the four main deck beams fitted only, remaining parts of kit being sent loose.

Hull primed 1 coat outside and varnished 1 coat inside.

**£76/0/0**  
ex works

**FINISHED BOATS**

Varnished and painted to specified colour

**£105/0/0**  
ex works

Boats are made and finished to a very high standard of workmanship. Brass Keelband and stem head fitting are fitted, other fittings can be included at prices shewn in previous column.

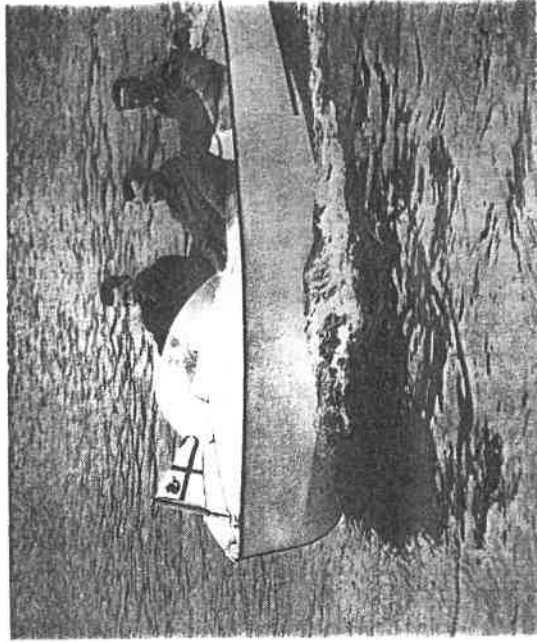

Good weight carrier.

Although designed as an outboard runabout this design lends itself admirably to inboard propulsion. Special kit is available for this purpose at the same price as standard.

# PARKER

## THE FOURTEEN-SIX RUNABOUT

Designed by F. E. I. R. PARKER & PARTNERS, LTD.

LENGTH 14ft. 6ins. BEAM 5ft. 0ins.  
SUITABLE FOR INBOARD OR OUTBOARD MOTORS 4 TO 10 H.P.

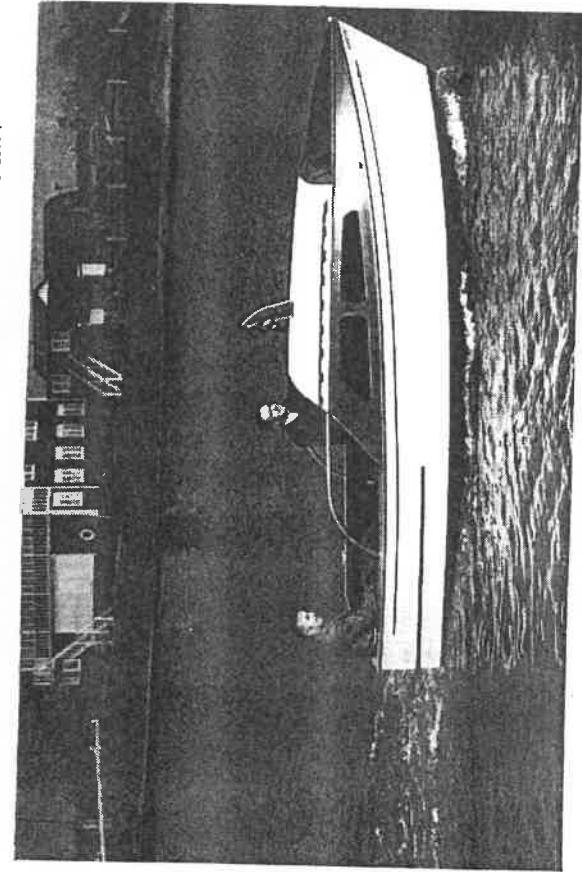

6 TO 7 M.P.H. WITH 4 B.H.P. INBOARD MOTOR.

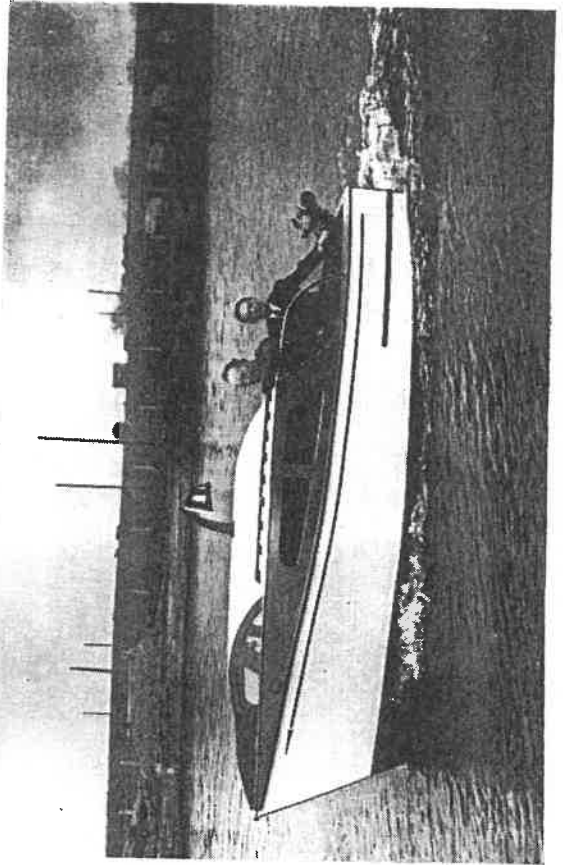

EASILY DRIVEN BY 4 B.H.P. OUTBOARD.

We adopted this design for prefabrication as it represented a hitherto unheard of conception of such accommodation and pleasing lines in so small a boat.

The design first appeared in the August 22/52 issue of "Yachts and Yachting" but escaped our notice at the time. Our attention was quickly drawn to this by the unusual number of letters which arrived at our Office asking "Are you going to prefabricate this boat as it is just what I want."

Reference to the article soon convinced us that their enthusiasm was justified, and the design ideal for prefabrication.

We immediately entered into an arrangement with the Designers and built a prototype, making several minor alterations in order to make assembly easy and foolproof.

The results by Trials with inboard and outboard engines exceeded our expectations, manoeuvrability and stability being all we could desire. General opinion can be summed up by the following conversation which took place at the time, between a young married couple and ourselves:—

"This is just the job for us Betty. We could have some wonderful week-ends on the river (Upper Thames) with this." The young man then turned to us and asked, "Do you think we could take it on a Trailer when we go away on holiday bearing in mind that we've already got an outboard motor which we'd like to use."

"Certainly, the man who has bought this one (inboard version) proposes to trail it to two or three places next year and his boat for loading purposes will be at least 100lbs. heavier than yours."

"You say the basic wooden kit costs £75, but what will it cost me to finish the job excluding furnishings and utensils."

"Assuming that you only want normal locker space and seating you should complete for £95, easily."

"If that's all it adds up to you're certainly going to give a lot of pleasure to a lot of people with this boat. How soon can we have a kit? I'll get as much pleasure in building it as using it. Can I have the building instructions at once to enable me to get the Garage floor marked out? Then I'll be ready to set up the frames as soon as they arrive."

This is, no doubt, an extremely cheap boat. The low price is only achieved by bulk buying and complete jiggling for all parts. Nothing is sacrificed by way of cheap materials; only the best timber and plywood is supplied. In fact, bearing in mind that this boat will always be at moorings except for an annual scrub or repairs, we have arranged with the plywood manufacturers to supply 5-ply Sapele plywood made to AX 100 grade of BSS 1088. Sapele is an extremely dense type of Mahogany which when manufactured to AX 100 specification results in the strongest and most water-resistant Mahogany planking available. (AX 100 plywood stands six hours boiling test).

Following our usual practice we offer a complete set of prefabricated timber parts to build the complete Hull with floorboards; this is the Basic Kit. Fittings, fastenings, etc., are itemised separately to suit individual requirements.

## BASIC KIT

All frames and transom are sent out ready assembled for immediate setting up for building; these, like the inner stem, are machined ready to receive (after slight fairing in) the hog, chines, gunwales, stringers, cabin clamps and king planks and these, too, are ready for use. In fact, except for a little fairing in, the whole assembly—as shown in illustration—can be put together by screws and glue ready to fair off in order to receive plywood planking without having to use more than a chisel (or gauge), plane, drill and screwdriver.

All parts are numbered for three reasons: To check the kit; identification of all parts on the plans; and to indicate correct sequence of assembly. This method and the straightforward detailed plans leave nothing to chance.

Plywood planking panels are sent out slightly over-size to allow for fitting and cleaning off.

Window openings are routed out and moulded ready to receive the special rubber glazing strip.

List of Basic Kit is as follows:—

- |                                   |                                    |
|-----------------------------------|------------------------------------|
| 1—6 Main frames complete          | 39 Cabin clamps (2)                |
| 7 Inner Stem                      | 40 Intermediate cabin beam         |
| 8 Inner Knee                      | 41 " "                             |
| 9 Transom complete                | 42 Cabin King plank                |
| 10 Transom Knee                   | 43 Frame 4 (b'hd.) Panels (2)      |
| 11 Strut to For'd Knee            | 44 Gunwale clamps (2)              |
| 11a Aft Strut                     | 45 Forward G-wale clamps (2)       |
| 12 Hog                            | 46 Aft Quarter knees (2)           |
| 13 Port Chine                     | 47 Carlin support block (2)        |
| 14 Starboard Chine                | 47a Carlins (2)                    |
| 15 Port Gunwale                   | 48 1/2" ply side decks (2)         |
| 16 Starboard Gunwale              | 49 Aft Cabin side support (2)      |
| 17 Bottom Stringers (2)           | 50 Aft Gunwale clamps (2)          |
| 18 Side Stringers (2)             | 51 Cabin side 5/16" ply port stbd. |
| 19 Port bottom                    | 52 1/2" plywood Cabin top (2)      |
| 20 S'board bottom                 | 53 Bulwark capping (2)             |
| 21 Port side                      | 54 Cockpit Carlin trim (2)         |
| 22 S'board side                   | 55 Transom capping                 |
| 23 Keel                           | 56 Rubbing strakes (2)             |
| 24 For'd bottom panel, port stbd. | 57 Lower rubbers                   |
| 25 " " " port stbd.               | 58 Motif beads & arrows (2)        |
| 26 Aft " " " port stbd.           | 59 H/R Beading (6)                 |
| 27 Forward side, port             | 60 Bevelled stem block             |
| 28 Forward side, stbd.            | 61 Pair Door Posts (2)             |
| 29 Aft side, port                 | 62 Burgee Mast plate               |
| 30 Aft side, stbd.                | 63 Cabin Top foot rails (2)        |
| 31 Outer stem foot                | 64 Door panel & draught strip      |
| 32 Outer stem                     | 65 Door panel styles (4)           |
| 33 Bilge rubbers (2)              | 66 Floorboards (10)                |
| 34 Breasthook                     | 67 Floorboard Bearers (2)          |
| 35 Cabin front                    |                                    |
| 36 Deck King plank                |                                    |
| 37 Pr. 1/2 ply deck panels (2)    |                                    |

Cost of BASIC KIT, including Plans, assembly instructions, Designer's Royalty and copy of "Home Boat Building."

**£75 0 0d.**

Carriage paid Inland or U.K. ports.

Channel Islands and Eire **£1 10s. 0d.** extra.

A deposit of 20/- is charged extra on the packing crate. This amount is refunded in full when the crate timbers are returned to our works, carriage paid, bearing the sender's name and relative invoice number.

Extra 5/16" plywood for Bunks, Lockers, etc., if required 2/3d. per ft. super.

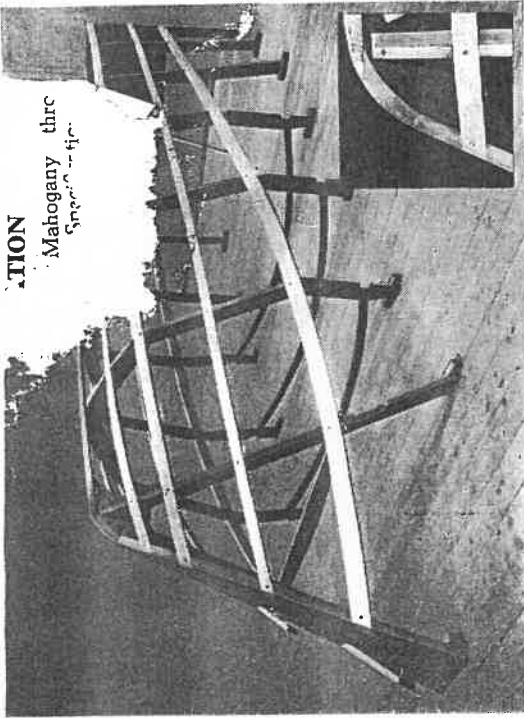

MAHOGANY THRU

## INBOARD MOTORS.

The Fourteen-Six is ideally suited for Inboard Motors from 4 h.p. to 10 h.p. This gives an extremely wide choice engines.

The short list below gives useful comparisons:—

Anzani 4 h.p. lightweight (52lbs.), neutral and reverse. Portable Power Head (stern extra) .....	£49 10 0c
Stuart Turner 4 h.p. Clutch (no reverse) complete with stern gear .....	£87 0 0c
As above but with reverse gear .....	£95 0 0c
Fisherboy Ford 10 Marine unit, complete with stern gear .....	£150 0 0c

Extra items to complete Inboard installation if not included in above prices:—

Rudder, complete with split gudgeons, special fixing bolts and tiller arm, all well machined in brass .....	£10 5 0
Special brass A bracket with skeg and Dunlop rubber bearing .....	£6 17 0c
Special Brass stern tube, complete with gland .....	£6 3 0
Stuart adjustable metal shaft log .....	£8 10 0
12" Brass Steering Wheel with wood handles and drum .....	£4 10 0
Set of tackle to complete steering, i.e. 3 lengths of spliced galvanized flexible p.s.w. cable, 2 shackles, 4 Aero Links, two 5 cwt. strainers and five boxed sheaves .....	£2 8 0

## FINISHED BOATS AVAILABLE from

£150 ex works, less motor

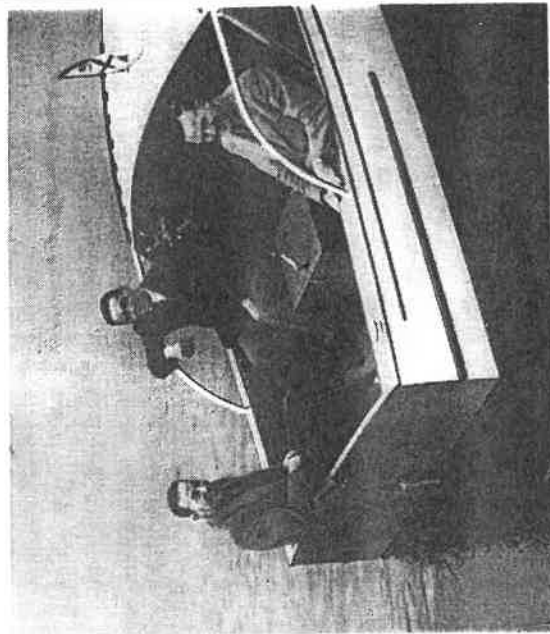

AMPLE ROOM IN COCKPIT DESPITE INBOARD MOTOR.

## FASTENINGS, GLUE, ETC.

1/2 gross 3/4" x 8" 6 only	1 1/2" x 10"
5 dozen 5/8" x 6" 15 only	1 3/4" x 10"
2 1/2 gross 3/4" x 6" 5 dozen	2" x 10"
5 dozen 1 1/4" x 6" 2 only	2 1/2" x 10"

6—3/8" Galvanized Bolts and Nuts.

3lbs. Aerolite 300 Glue and 1lb. Hardener  
£7 0s. 0d. (Carriage Paid).

Glueing instructions included.

## FITTINGS.

Stem Head fairlead, polished brass } for rope	
4" For'd deck cleat, polished brass } Warp	18/- pair
alternatively :	
Stem Head fairlead, polished brass } for chain	
6" For'd deck cleat, polished brass } Warp	£1/2/0 pair
3" aft quarter cleats, polished brass	9/- pair
Drawn brass Handrails (if wanted)	£2/12/6 pair

## SPECIAL RUBBER GLAZING STRIP.

40 feet lineal with fixing instructions and loan of special tool for glazing 3/8" glass .....

Returnable deposit on glazing tool £1

NOTE:—Glass is best obtained from local source.

## SUITABLE OUTBOARD MOTORS

Seagull long shaft 102 Model (4 h.p.) .....	£42 0 0d.
Seagull long shaft clutch 102 Model .....	£47 0 0d.
Anzani long shaft 10 h.p. Unitwin .....	£89 10 0d.
Anzani long shaft 4 h.p. Super Single .....	£49 0 0d.



The idea for this small motor cruiser first occurred to me during the winter, when ruminating on how nice it would be to own a small, easily handled cabin boat to explore the canals, rivers and estuaries; one that could be kept with very little expense, and yet afford the facilities of a much bigger craft. It was from this humble pipe dream that "Rutland" first appeared on the drawing board.

The requirement was not for a cruiser de luxe with 6 ft. of headroom, but for a 16-ft. cabin boat of pleasing appearance and not too much top hamper, suitable for spending an occasional week-end aboard, capable of taking the family for a day's outing, and with a cockpit large enough for fishing, etc. She is not offered as a seagoing cross-Channel craft, but with a view to enjoying the pleasures of the river and estuary, where she will be perfectly safe. "Rutland" is also suitable for short coastal runs in fair weather within easy reach of shelter.

"Rutland" is, perhaps, the smallest practical motor cruiser to have sleeping accommodation, and is designed especially for the amateur constructor to build in a garage or shed—or even in the backyard, provided she can be protected from the weather by a tarpaulin.

The dimensions are: Length, 16ft. or 18ft. beam, 6ft., draught, 1ft. 6ins. Chine construction was decided upon with a view to simplifying the building for the amateur. The sections, transom and stem details are drawn out full size, so avoiding the tedious job of laying-off the lines. The working drawings show constructional details and should be

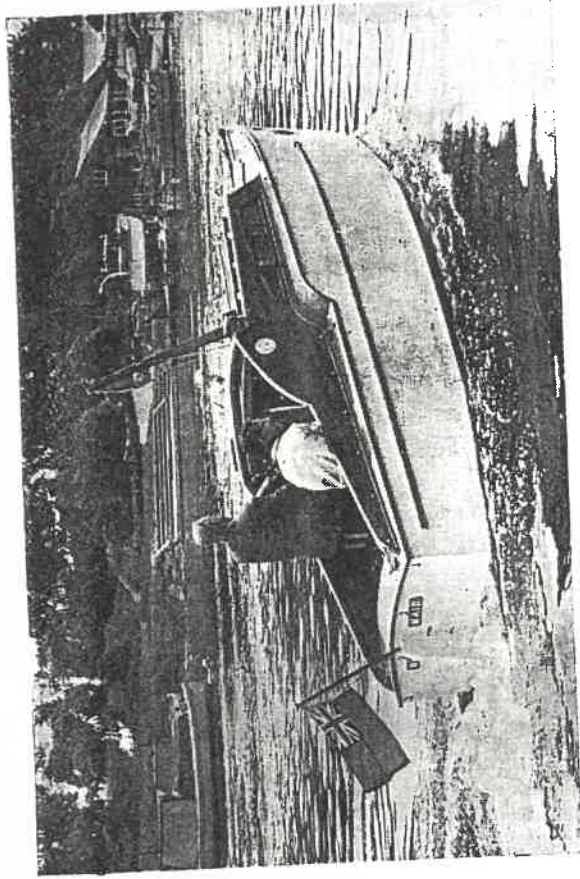

read in conjunction with the specification and building instructions.

It is assumed that the prospective builder has some knowledge of woodworking or has access to some good boatbuilding books. The amateur with moderate experience should not find any trouble building "Rutland," as chine construction is straightforward.

The plans are self-explanatory. It will be noted that the cabin is arranged with two 6-ft. settee berths, giving full sitting headroom under the beams. Right forward there is a rope locker. The settee tops have locker lids, and there are hatches in the flooring to facilitate access to the bilges. Fixed windows are fitted port and starboard, and in the fore end of the cabin trunk. A toilet compartment is arranged on the port side by lifting the top of the sideboard and hooking the canvas curtain to the doorposts. On the starboard side is a cooking platform, to take a primus or similar stove and a washbowl. Double doors open outwards into the cockpit, although when an inboard engine is fitted it is arranged that the top half only of the port door shall open. There are port and starboard seats in the cockpit with locker lids arranged in the tops.

The steering wheel is fitted on the port side of the main bulkhead, and it will be noted that a helmsmans seat is provided. When an inboard engine is installed, the engine case is fitted up to the main bulkhead. Hatches are arranged in the cockpit floor.

For outboard propulsion, a well is provided in the aft deck at the transom, and it is large enough to take two motors at once if desired. Even when an inboard engine is installed, some owners may wish to have an outboard as auxiliary, and it could remain in position ready for use.

Choice of engines will depend on the owners' requirements or pocket, but it is recommended that a 4 h.p. or 6 h.p. engine be installed to attain a mean speed of 6-7½ m.p.h., which is considered to be an economical speed for this design. An 8 h.p. engine can be installed, provided the weight of the inboard unit does not exceed 300 lb. Some owners may be tempted to install more power, but will be disappointed to find little improvement in the speed, and she will make more fuss when under way.

A word of warning—please do not depart from the given dimensions, and in particular do not attempt to increase the headroom, as it will upset the balance of the profile and you will be disappointed with the results.

**It is permissible to lengthen the boat up to 18ft. and this is done by spacing the frames 2ft. 3ins. instead of 2ft. and re-arranging the plywood joints to suit.**

Apart from the plans and timber, all that is needed is an ordinary set of carpenter's tools, the space for building and the ambition to own this little ship, which should prove inexpensive to build.



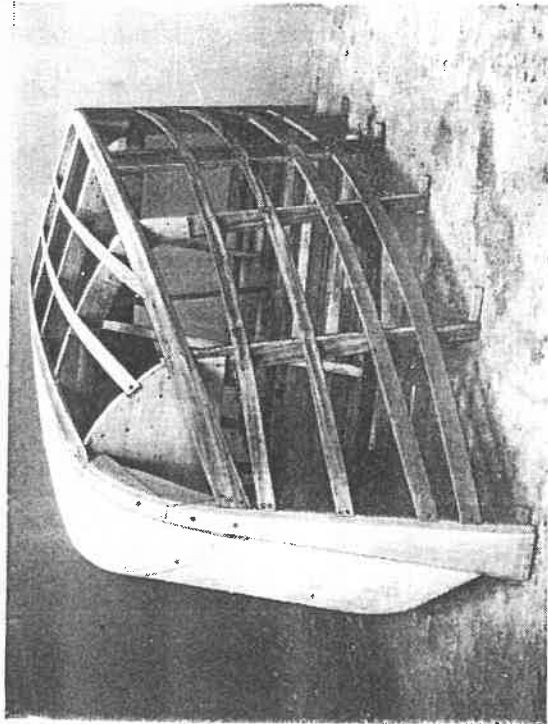

Showing Plywood Finishing on Inner Stem

### SET OF PREFABRICATED WOODEN PARTS

As no two people will finish off the boat alike we offer a set of parts to complete the hull itself leaving the builder to obtain floorboards and interior scantlings and the like locally. These with one or two exceptions are straight-forward sections and it seems pointless to pay for packing and carriage on such items. Should a builder find such items unobtainable locally, however, we shall be pleased to quote against his list. The set of parts is therefore as follows:—

- |    |                           |   |                                |       |                            |
|----|---------------------------|---|--------------------------------|-------|----------------------------|
| 16 | Frame bottom members      | 2 | Corner posts                   | 1     | Hog                        |
| 18 | Frame side members        | 2 | Aft posts                      | 2     | Chine Fillers              |
| 14 | Frame Top Knees           | 2 | Backing pieces for Cabin sides | 1     | Keel                       |
| 14 | Frame Bottom Knees        | 2 | Foredeck facing piece          | 2     | Beam Stringers             |
| 7  | Floors                    | 4 | Coaming cappings               | 4     | Carlines                   |
| 7  | Deck Beams                | 4 | Coaming cappings supports      | 60ft. | Cabin Beading              |
| 6  | Backing pieces            | 4 | Deck and Cabin Joint Beads     | 42ft. | Deck and Cabin Joint Beads |
| 1  | Apron Unit made up        | 1 | Deck centre line covering      |       |                            |
| 1  | Transom well strong back  | 1 | Cabin Centre line              |       |                            |
| 1  | Keel stern-tube part      | 1 | Shaped door head board         |       |                            |
| 1  | Rudder Blade              | 2 | Main door posts                |       |                            |
| 2  | Rudder Cheeks             | 4 | Intermediate frame knees       |       |                            |
| 1  | Stem in three parts       | 4 | Cabin roof brackets            |       |                            |
| 1  | Stern Knee                | 5 | Cabin roof beams               |       |                            |
| 1  | Breasthook                | 2 | Sheer curves                   |       |                            |
| 1  | Transom well framing      | 2 | Carlin curves                  |       |                            |
| 2  | Transom stiffening knees  | 2 | Gunwales                       |       |                            |
| 2  | Cabin fronts              | 2 | Sheer stringers                |       |                            |
| 1  | Cabin front backing piece | 4 | Sheer rubbers                  |       |                            |
| 2  | Windshields               | 2 | Rubbing strake curves          |       |                            |
| 1  | do. backing piece         | 2 | Lower rubbers                  |       |                            |
| 2  | Upright posts             | 2 | Chines                         |       |                            |
|    |                           | 3 | Intermediate stringers         |       |                            |

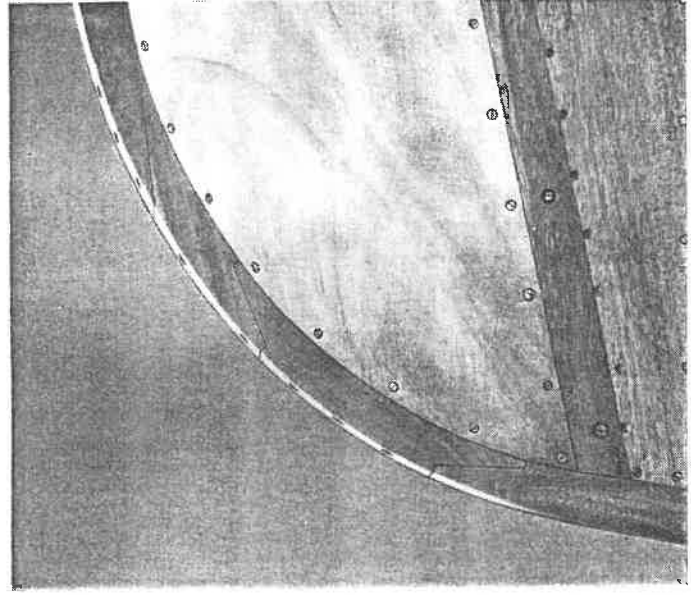

Detail of Outer Stem

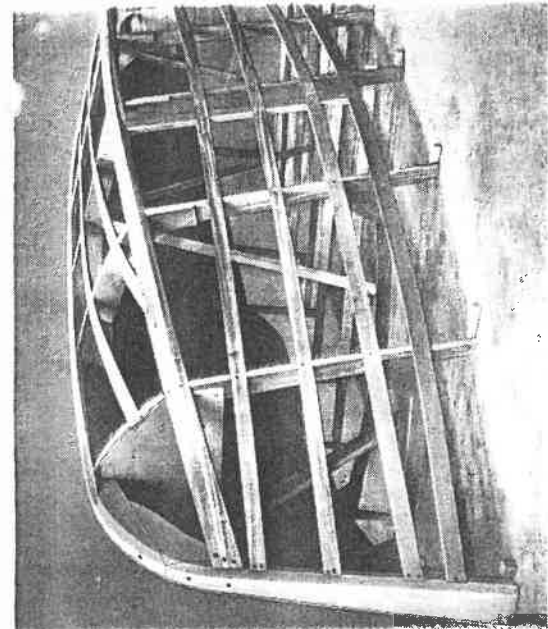

General Set up and Stem Detail

**SPECIFICATION**  
All Plywood is supplied in Mahogany throughout manufactured to British Standard Specification 1088.

Chines, Gunwales and Stringers, prime Sitka Spruce. All remaining timbers are prime knot free Mahogany and machined as far as possible. Frames can be assembled on the full size drawing, the framing being machined ready to take Stringers, Chines and Hog. Brackets and floors are drilled and countersunk. Stem Chines is bevelled as required. Keel and Deadwood are shaped ready for final fitting, all beams are to correct camber. Cabin sides and front are also ready for fitting, rebated recesses are ready cut to receive glass direct.

The timber used in the packing crate is planed up square and can be re-used for bearers, struts, lifts, etc., when completing the boat.

Price: 16' ..... £107 10 0 crated and delivered  
18' ..... £116 0 0 crated and delivered

Price is the same whether inboard or outboard version is required.

Motors (see previous page)

### PLANS

A set of plans must be obtained from a kit of parts. Full set of building including full-size sections and stem together with set of building instructions available only from Mr. H. H. Davies, Mr. Runnymede Gardens, Whitton, Twickenham, Middlesex. Price £3 5s. 0d. per set.

### FASTENINGS

Set of brass screws, copper nails, Cadmium Plated Keel Bolts, Aerolite Glue Hardener £12 5s. 0d. delivered.

### BRASS RUDDER GEAR

Set of two pintles and gudgeons with Arm and Cadmium Plated Keel Fitting for Foot. £4 14s. 0d. Carriage and Packing 5/- extra.

### ASSEMBLED HULL

Hull comprising the complete assembled parts specified in the Kit, one coat of primer Hull exterior. 16ft. ... £195 0 0d. ex works 18ft. ... £210 0 0d. ex works

Terms: Strictly nett cash with or against Pro-Forma Invoice.

## OUR TERMS OF BUSINESS

### PAYMENT.

All goods are priced on a nett cash basis and we must therefore request Cash with Order or against our Invoice prior to despatch.

### CARRIAGE.

All kits are carriage paid to U.K. addresses or to U.K. Ports. Finished boats are priced ex-works. Quotations for Railway Containers or Special Road Delivery of complete boats and hulls will be given promptly on request. Many customers are able to make arrangement for the collection of their dinghies from our works. This is to be preferred where possible although it is essential that boats be collected within three days of advised completion date. After this time boats are stored at owner's risk.

### PACKING CASES AND CRATES.

We are compelled to make a charge for these but if they are returned carriage paid to our works their deposits will be promptly refunded. It would be appreciated if all packing materials including paper, etc., be returned in the cases as such materials are in short supply. Crates may be taken down for return but you should be sure to leave your name securely on the returned timbers to enable us to credit you on receipt.

### CLAIMS FOR DAMAGE OR LOSSES IN TRANSIT.

When consignments arrive in a very badly damaged condition you should refuse to accept delivery instructing the carriers to return the goods to us at their expense. If the goods are slightly damaged sign for them as "Received Damaged" and send a written notification of the damage to the carrier and to ourselves on the day of arrival or the day after at the very latest. Only three days are allowed in which we may make our own notification at this end and place our claim. In any case you should sign the carriers' receipts as received "unexamined." Items found to be damaged on unpacking should be returned to us promptly for replacement. We will replace items returned to us within 7 days of receiving the kit.

**BELL WOODWORKING CO. LTD.**  
**PERCY ROAD, AYLESTONE PARK, LEICESTER**

PHONES: ~~324180~~ & ~~324666~~  
(Evenings: Wigston 2524)

